

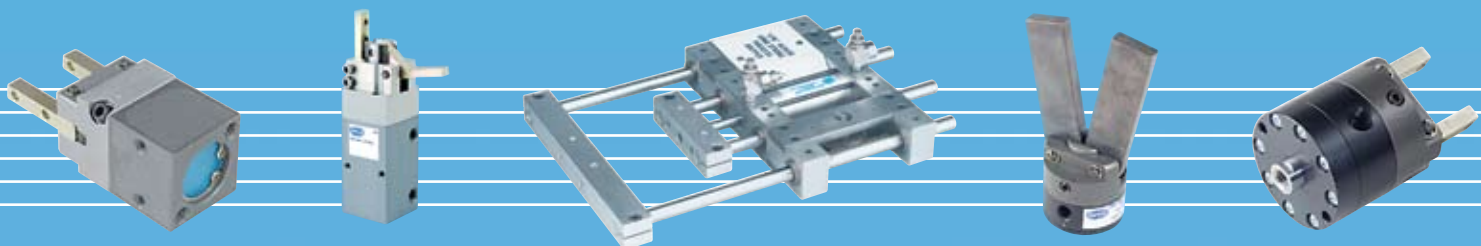

Precision Pneumatic Grippers



***Advanced Parallel & Angular
Jaw Motion Designs***



Product Index



SPG Series – Parallel Jaw Motion Grippers

Product Selection Guide.....	6
How to Order	7
Application Tips	5
Competitive Analysis	4 & 5
Construction	3
Dimensions	
SPG100, 200 & 300 Models.....	8, 9
SPG600 Models	10, 11
High Force Models	9 & 11
Long Stroke Models	9 & 11
Sensor Options.....	12, 13
Other Options	14, 15



GR & GS Series – Angular Jaw Motion Grippers

Product Selection Guide.....	16
How to Order	17
Construction	16
Dimensions	
GR Series– Round Body Models	18
GS Series Square Body Models	19
GS Series Miniature Models	19
Gripper Jaws.....	18 & 19
Sensor Options.....	17
Other Options	17



LPG Series – Parallel Jaw Motion for Large Parts, Long Strokes

Construction	20
How to Order	21
How it Works.....	20
Dimensions	
TBF Models	22
TFR Models	23
Sensor Options.....	20 & 21
Other Options	20 & 21

"SPG" Series Parallel Grippers

Five steps to building the finest grippers available. . .

(1) Start with a pair of symmetrical jaws

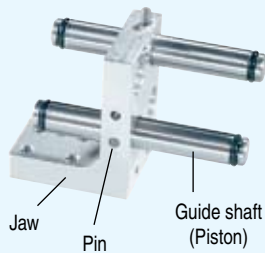

Integral Jaw/Guide Shaft/Piston Assembly

A pair of ground, stainless steel guide shafts (which double as air pistons) are press fit and pinned to each gripper jaw. Jaws can be aluminum or steel. Shafts are placed diagonally and spaced far apart for maximum jaw stability.

(2) Couple the mating internal parts

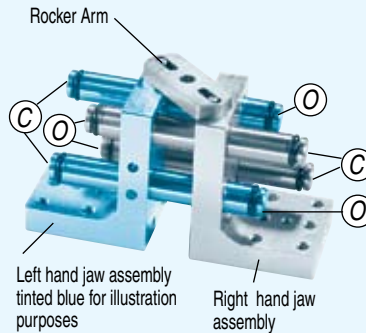

Only Three Moving Parts

Two jaw units are linked by a rocker arm that synchronizes jaw motion. The arm does not drive the jaws so wear is minimal.

The shaft/pistons of each jaw pass freely thru enlarged holes in its mate. "C" in the photo indicates the opposing piston faces to which air pressure is applied for jaw closing. "O" targets the opposing "jaw open" faces.

(3) Add one symmetrical cylinder block

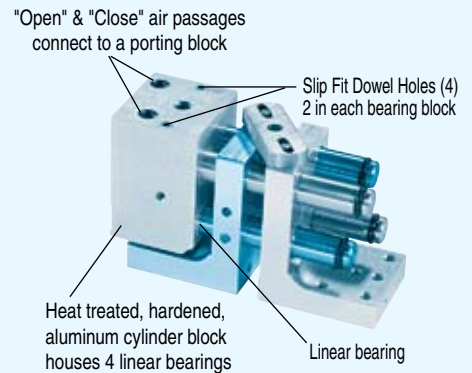

Four Cylinders in Each Block

are connected by internal air passages to the "C" and "O" piston faces shown in the step 2 photo.

Each cylinder incorporates permanently lubricated, high-performance linear bearings that provide clean, drip-proof operation and allow use of a non-lubricated air supply. Opening and closing forces are equal, allowing the grippers to be used for both OD & ID gripping.

(4) Add the other cylinder block and dowel the porting block on top

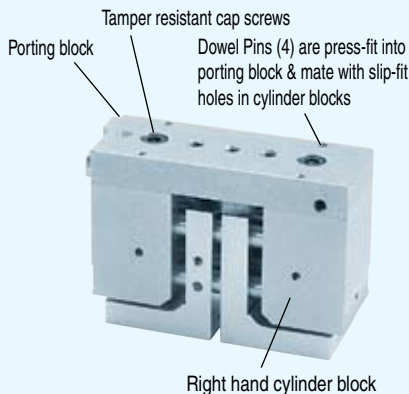

No Troublesome Gibs to Wear or Adjust.

Four dowel pins align the porting block perfectly with the cylinder blocks. Eight high-performance linear bearings guide the four pistons through the entire length of the gripper body. Centering accuracy is maintained to .002" and side play is .0015" or less per jaw. Most applications can expect extended gripper life to 15 million cycles – and even more!

(5) Apply this patented design to a wide range of sizes, strokes and grip forces. Then, offer all the convenient options that cannot be found on other grippers.

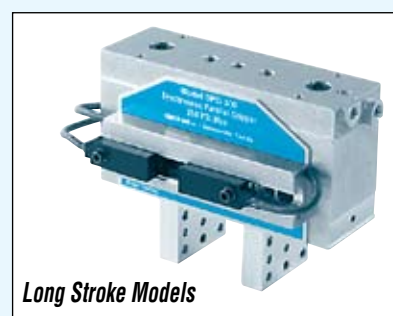

“SPG” Series Parallel Grippers

Problem #1: Conventional grippers place the power cylinder some distance above the jaw. The jaw is driven by a “linkage” that creates a “bending moment” which results in loss of force and creates wear points for future maintenance headaches.

Solution: SPG Gripper jaws are powered directly by air pressure applied to the ends of the guide shafts which act as pistons. Four equal pistons power the jaws inward; four equal pistons power the jaws outward.

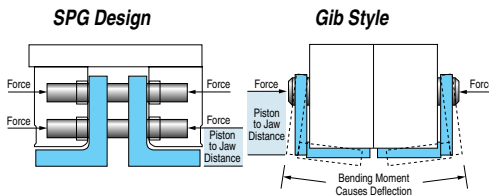

Reduced Jaw Deflection

SPG Grippers have eliminated complex piston-to-jaw linkages and gibs. Bending moments are significantly reduced because force is applied directly to the jaw units at a distance very close to the gripping surface. Loss of force is minimized. Opening & closing forces are equal for use with either ID or OD gripping.

Problem #2: Many grippers have “metal on metal” sliding gib in a “T” slot.

Solution: SPG Gripper jaws are guided by four stainless steel guide shafts supported by eight high-performance linear bearings.

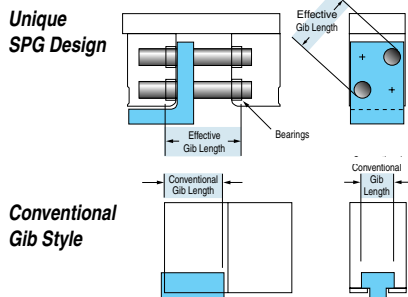

Long Term Performance

SPG guide shafts are placed far apart for sturdy “play free” jaw support. Gib type designs have metal-to-metal sliding contact and a narrow support area that can deflect and cause play.

Problem #3: It is difficult to attach tooling to competitive gripper jaws.

Solution: SPG Grippers offer a choice of jaw styles for easy attachment of tooling.

Note that all SPG Gripper jaws have three rows of tapped mounting holes and dowel holes for increased versatility. SPG Gripper jaws are available in steel or aluminum.

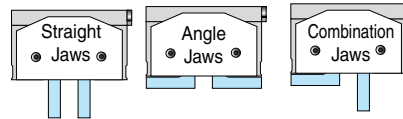

(a) Straight Jaws (J1-Aluminum or J3-Steel) are ideal for attaching blade type gripping fingers.

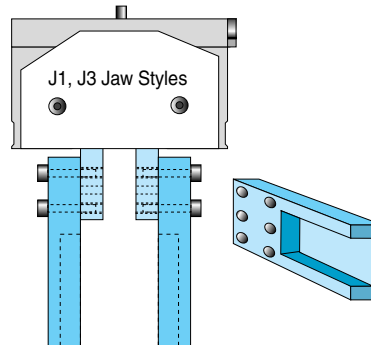

Here, jaws provide opposing flat mounting surfaces for inexpensive fingers with pockets used to grip rectangular parts.

(b) Angle Jaws (J2-Aluminum or J4-Steel) have a slip fit dowel hole and a slip fit dowel slot, assuring precise slip fit attachment of end tooling without the expense of maintaining perfect dowel centerlines.

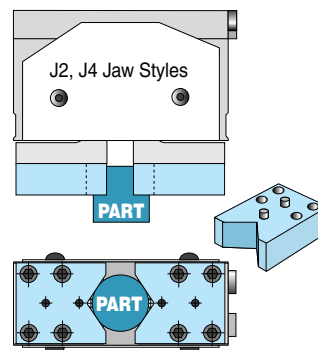

Here, the J2/J4 angle jaws and easy-to-make “Vee Blocks” are used to grip cylindrical parts.

(c) Interface blocks (“Option H”) can be attached to J2/J4 angle jaws allowing tooling to be mounted on any side of the block. Below, option “H” Interface Blocks have been utilized to provide side tapped holes for mounting offset blade type gripping fingers.

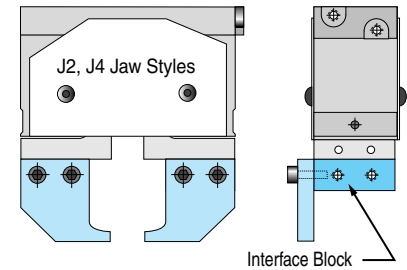

Problem #4: Competitive grippers do not hold tolerances close enough that a replacement gripper can be installed without major readjustment and realignment.

Solution: SPG Grippers are very precisely machined on a specially tooled 4-axis CNC machining center.

Fabco-Air does 100% of the gripper manufacturing in-house, insuring that SPG Grippers interchange perfectly with each other. SPG Gripper jaws close completely together

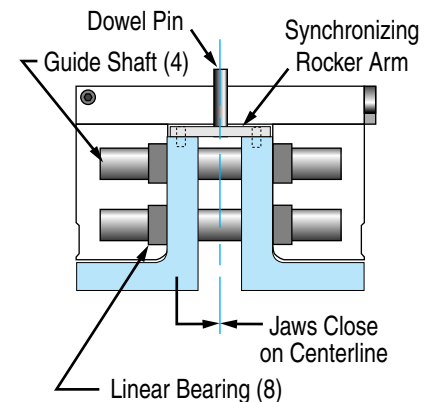

against one another, establishing gripper centerline. The dowel pin, on which the rocker arm pivots to establish centering, serves a dual purpose. It also is the dowel that the customer uses to engage his tooling. Thus, all centerlines are one and the same!!

Solving conventional gripper problems with only 3 moving parts!

Problem #5: Competitive grippers are difficult to repair – lots of parts, etc.

Solution: SPG Grippers have only three moving parts, and six total!

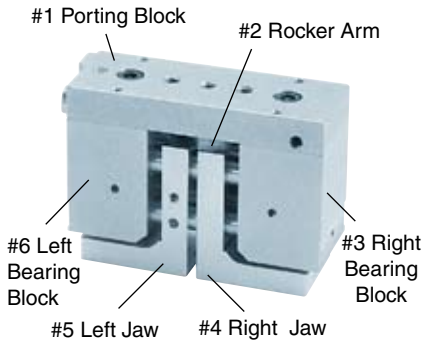

Left and right jaws are identical. Left and right cylinder blocks are identical. Porting block is doweled to cylinder blocks. SPG grippers are easy to repair. They can be disassembled and reassembled in minutes – literally!

There is no adjusting of gibs, no "timing" or "synchronization" of mating parts. Replacement of wear parts is generally limited to seals – and possibly the synchronizing rocker arm!

Problem #6: Competitive grippers are difficult to attach to their mating actuator arm.

Solution: SPG Grippers can be easily doweled into mounting surfaces with either of the following approaches:

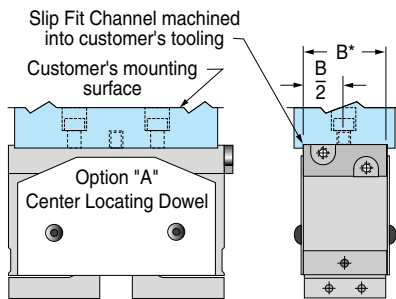

(1) Use SPG Gripper "Option A" which provides a center locating dowel on top of the gripper. Machine a slip fit channel .030" deep into customer's tooling to accept Gripper

dimension "B". "B" is machined to a tolerance of $\pm .001$ on all SPG Models. Mounting the gripper is accomplished by "slipping" the gripper's dowel into a slip fit dowel hole and pushing the gripper into the machined channel. Removal is easy and does not require "prying" the gripper off of two "stuck" dowel holes.

(2) The second method utilizes the slip fit dowel slot that is included with the center locating dowel pin "Option A". The center dowel pin establishes gripper centerline on

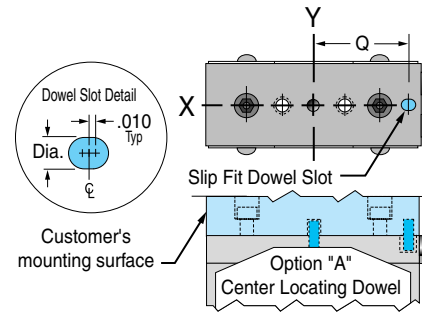

an X-Y plane. The end dowel locates the X Axis preventing rotation. The "Q" dimension is not critical. It can be held to $\pm .005$ and still provide precision engagement in the gripper dowel slot.

Fabco-Air SPG Grippers are very versatile and can be modified to suit special applications as described in the following examples.

Special Example #1

Verifying parts presence and/or gauging

The symmetrical nature of the SPG Gripper allows a pair of prox sensors to be installed on each side. Two sensors on one side of the gripper are used to verify full open and full close jaw positions.

The two sensors on the opposite side can be set so that each sensor is "just made" when a part is gripped. An oversize, under-size, or missing part will cause enough jaw travel that one of the two sensors will "drop out", indicating a "no go" situation. If both sensors are "made", a gripped part is present and within tolerance.

Special Example #2

Three position jaws

Fabco-Air has made three-position grippers by modifying the booster piston of a **High Force SPG Gripper** and installing it at one end of the gripper. Line pressure applied to this booster piston overrides "Jaw Open"

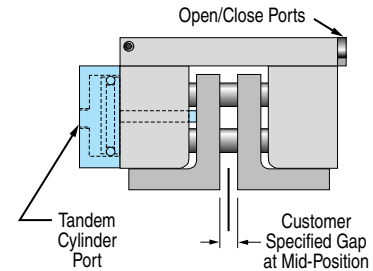

pressure – and will position the jaws in a "mid" location. From this "mid" position, the jaws can be either opened or closed allowing I.D. or O.D. gripping if a family of parts is to be handled with the same gripper.

Special Example #3

Application tip – Escapement Device

The SPG Gripper can be used as a programmable escapement device by simply specifying option "Q", non-synchronous motion. In this configuration each jaw can be operated independently with its own 4-way air valve. "Tick-tock" tooling fingers can be attached to the jaws and two sets of sensors added to provide "open/close" verification for each jaw.

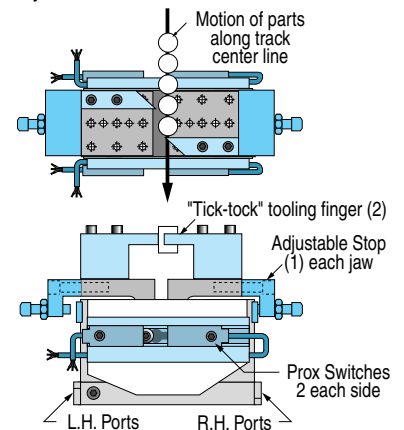

Typical Escapement Sequence:

- 1) Left jaw closes
- 2) Right jaw opens (part escapes)
- 3) Right jaw closes
- 4) Left jaw opens (letting another part in)

"SPG" Series Parallel Grippers

Gripper Selection Guide

Choice of Stroke & Grip Force

Model	Stroke (Open)	Grip Force Per Jaw at 100 psi	
		Closing	Opening
SPG 100	0.25"	5.5 lbs	5.5 lbs
SPG 200	0.40"	9.8 lbs	9.8 lbs
SPG 300	0.54"	22 lbs	22 lbs
SPG 300LS	1.16"	22 lbs	22 lbs
SPG 300HF	0.54"	100 lbs	22 lbs
SPG 300LSHF	1.16"	100 lbs	22 lbs
SPG 600	1.38"	88 lbs	88 lbs
SPG 600LS	3.75"	88 lbs	88 lbs
SPG 600HF	1.38"	402 lbs	88 lbs
SPG 600LSHF	3.75"	402 lbs	88 lbs

Choice of Jaw Styles

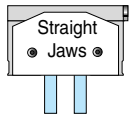

J1 – Aluminum
J3* – Steel

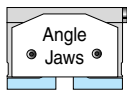

J2 – Aluminum
J4* – Steel

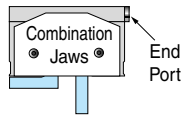

J1/J2 (shown), J2/J1, J3/J4*, or J4/J3*

List first the jaw you want near end port

***Note: Steel jaws are required on all high force models**

Standard Stroke Models

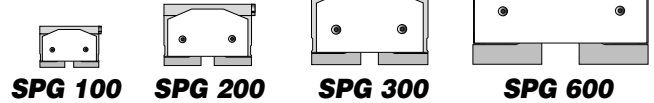

High Force Models

Jaw closing force is increased by Integral booster pistons.

Note:
Jaw opening force is *not* increased.

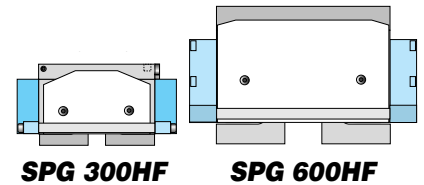

Long Stroke Models

Jaw opening is increased with greater guide shaft travel through longer cylinder blocks

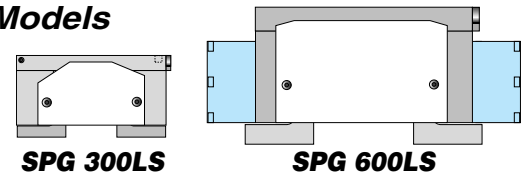

Long Stroke, High Force Models

incorporate both booster pistons and extended cylinder blocks

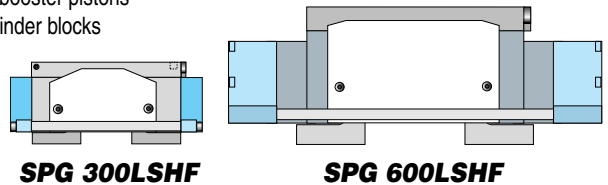

Choice of Sensors – See page 12 & 13

Proximity Switches, Front Face Mount



(Model SPG300LS shown)

Uses rectangular body proximity switches mounted in a T-slot bracket on the gripper face. Switches are actuated by a pin on one jaw.
Very precise sensing.



5mm Prox. Switches, End Mount – Threaded body prox. switches are mounted in a bracket on the gripper end and actuated by cap screw(s). **Available complete with switches or as brackets only.**

Electronic or Reed Switches, Front Face Mount

Electronic sensors or magnetic reed switches are mounted in a dovetail slotted extrusion on the gripper face and actuated by a magnet on one jaw.

Cost effective and compact.



(Model SPG200 shown)

Other Options – See page 14 & 15

Center Locating Dowel Pin – Option "A"

Dowel pin option establishes gripper centerline and includes an outboard dowel slot for precise alignment.



(Model SPG300HF shown)

Bumper Options "C", "D" & "E"

The SPG is the only gripper in its class to offer urethane bumper pads for quiet, high-speed cycling. Available on SPG200 and larger models for "open", "closed" or both positions. Can be "stacked" to limit stroke.

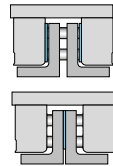

Spring Open Option "F" & Spring Close Option "G"

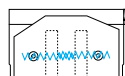
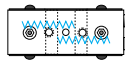

can be used to maintain grip force with loss of air pressure (fail safe) or as single acting grippers (single supply line to port).

Interface Blocks – Option "H"

Blocks provide a convenient way to attach endtooling to J2 and J4 style jaws. (Application shown on page 4, Problem #3C.)



Ports Front & Rear – Option "B"

Note: End ports plugged
Not available on SPG100 Models, SPG600 Models, or Long Stroke Models.

Non-Synchronous Compliant Type – Option "N"

This configuration is provided by simply removing the rocker arm that normally provides synchronization. Jaws will comply to the centerline established by the part to be gripped. The combination of equal piston forces and internal friction prevents jaw drift.

Non-Synchronous Fixed Reference Type – Option "P"

(J2 & J4 Jaw Styles Only)
Jaws operate completely independently thru 2 sets of ports (2 air valves required). One jaw is fitted with an adjustable stop for fixed reference point, and operates at 50% more psi.

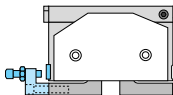

Escapement Device – Option "Q"

(J2 & J4 Jaw Styles Only)
Same as Option "P" except both jaws have adjustable stops and operate on equal pressure. (See page 5, special example #3.)

Viton Seals – Option "V"

Strain Relief – Option "R"

Air tubing is held by slotted clamps attached to the gripper face. Not available on High Force Models or SPG600 Models.



The extremely tough grippers that never need adjusting!

How to Order

Gripper Sizing Guide

Select a model based on stroke & grip force

Model	Stroke (Open)	Grip Force Per Jaw at 100 psi	
		Closing	Opening
SPG 100	0.25"	5.5 lbs	5.5 lbs
SPG 200	0.40"	9.8 lbs	9.8 lbs
SPG 300	0.54"	22 lbs	22 lbs
SPG 300LS	1.16"	22 lbs	22 lbs
SPG 300HF	0.54"	100 lbs	22 lbs
SPG 300LSHF	1.16"	100 lbs	22 lbs
SPG 600	1.38"	88 lbs	88 lbs
SPG 600LS	3.75"	88 lbs	88 lbs
SPG 600HF	1.38"	402 lbs	88 lbs
SPG 600LSHF	3.75"	402 lbs	88 lbs

Jaw Styles

- J1*Straight jaw – aluminum
- J3Straight jaw – steel
- J2*Angle jaw – aluminum
- J4Angle jaw – steel
- J1/J2# ... Combination jaws – aluminum
- J2/J1# .. Combination jaws – aluminum
- J3/J4# .. Combination jaws – steel
- J4/J3# ... Combination jaws – steel

*Note: J1 and J2 not available with high force models.

#Note: First jaw listed is closest to end ports

Fabco-Air welcomes your "specials!"
See special example numbers 1 – 3 on page 5.

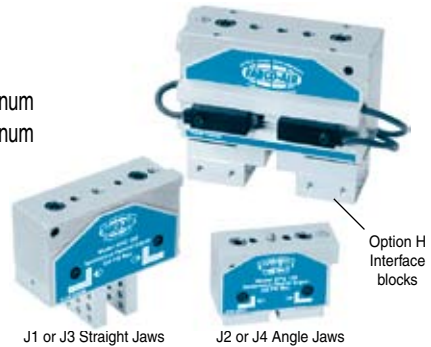

EXAMPLE

SPG 300

- J2

- S04

- ACFH

Model

Jaw style

Sensor options

Other options

Sensing Option Packages (Pages 12 & 13)

Use "S00" if NO Sensors desired

Proximity Switch Mounted On Front Face Of Gripper

Electrical characteristics – 24VDC, 3-wire w/LED

S01 – S05 Available on all models with J1 – J4 style jaws.

- S01 Single switch (PNP) sourcing
- S02 Single switch (NPN) sinking
- S03 Dual switch (PNP) sourcing
- S04 Dual switch (NPN) sinking
- S05 Switch package without switches

5mm Threaded Prox Switch Mounted On End Opposite Ports

Electrical characteristics – 24VDC, 3-wire w/LED

S11 – S15 Available on SPG200 & SPG300 with J2 / J4 style jaws. Not available on high force models.

- S11 Switch package without switches
- S12 Single switch (PNP) sourcing
- S13 Single switch (NPN) sinking
- S14 Dual switch (PNP) sourcing
- S15 Dual switch (NPN) sinking

5mm Threaded Prox Switch Mounted On Same End As Ports

Electrical characteristics – 24VDC, 3-wire w/LED

S16 – S20 Available on SPG200 & SPG300 with J2 / J4 style jaws. Not available on high force models.

- S16 Switch package without switches
- S17 Single switch (PNP) sourcing
- S18 Single switch (NPN) sinking
- S19 Dual switch (PNP) sourcing
- S20 Dual switch (NPN) sinking

Electronic Sensor Mounted On Front Face

Electrical characteristics – LED, 6-24 VDC, 0.20 Amp Max, 0.5 Volt Drop

E20 – E24 Available on all models with J1 – J4 style jaws.

Use Suffix 'C' for Quick Disconnect

- E20 Sensor package without sensors
- E21, E21C Single sensor (PNP) sourcing
- E22, E22C Single sensor (NPN) sinking
- E23, E23C Dual sensor (PNP) sourcing
- E24, E24C Dual sensor (NPN) sinking

Magnetic Reed Switch Mounted On Front Face

- E20 Switch package without switches
- E25, E25C Single switch, No LED, 0-120 VDC/VAC, 0.5 Amp Max, 5 Watt Max, 0 Voltage Drop
- E27, E27C Single switch LED, 5-120 VDC/VAC, 0.03 Amp Max, 4 Watt Max, 2.0 Voltage Drop
- E28, E28C Dual switch, No LED, 0-120 VDC/VAC, 0.5 Amp Max, 5 Watt Max, 0 Voltage Drop
- E30, E30C Dual switch, LED, 5-120 VDC/VAC, 0.03 Amp Max, 4 Watt Max, 2.0 Voltage Drop

E20, E25 – E30 Available on all models with J1 – J4 style jaws. Use Suffix 'C' for Quick Disconnect

Adjustable Stops Using Bumper Pads

Example C3
Quantity (3) Bumpers in each open position reduce open motion by 3 times bumper thickness

Quick Disconnect Cordsets for Electronic Sensors and Reed Switches

Codes E21C - E30C
Quick disconnect style switches are supplied with 6 inch pigtail with male connector.
Order female connector cordsets separately as follows:
CFC-1M 1 meter
CFC-2M 2 meters
CFC-5M 5 meters
Note: Prewired styles are supplied with nine foot leadwire.

Other Options (Pages 14 & 15)

- A Center locating dowel
 - 1, 2, 4 B Front & rear ports (end ports plugged)
 - 1 C Bumpers (2) to cushion opening
 - 1 D Bumper (1) to cushion closing
 - 1 E Bumpers (3) to cushion opening and closing motion
 - 1, 2, 3 F Spring option: Jaws spring open
 - 1, 2, 3 G Spring option: Jaws spring closed
 - 3 H Interface blocks (2) for J2/J4 Jaws
 - 1, 3 N Non-synchronous: compliant type
 - 1, 3 P Non-synchronous fixed ref. type
 - 1, 3 Q Escapement style
 - 3, 4 R Strain relief for air tubing
 - V Viton seals
- Exceptions**
- 1 Not available on Model SPG100
 - 2 Not available on long stroke models
 - 3 Not available on high force models
 - 4 Not available on SPG600 models

Ordering Example

SPG300LS - J1 - S04 - S02 - NV
Specifies a non-synchronous, compliant type, long stroke gripper with straight aluminum jaws, three face-mounted sinking proximity sensors (2 front/1 back), and Viton seals.



"SPG" Series Parallel Grippers

SPG 100, SPG 200 & SPG 300

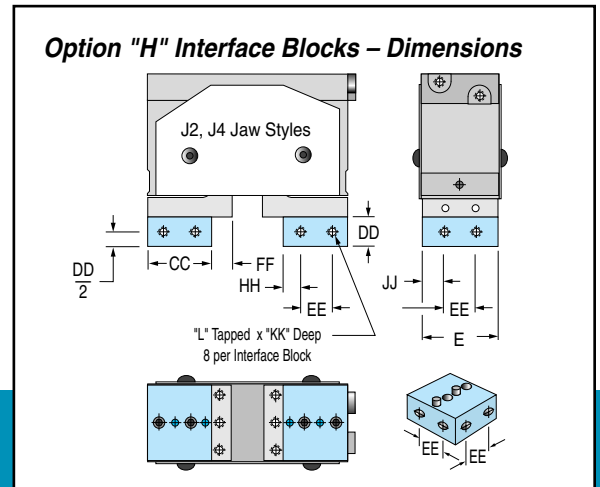
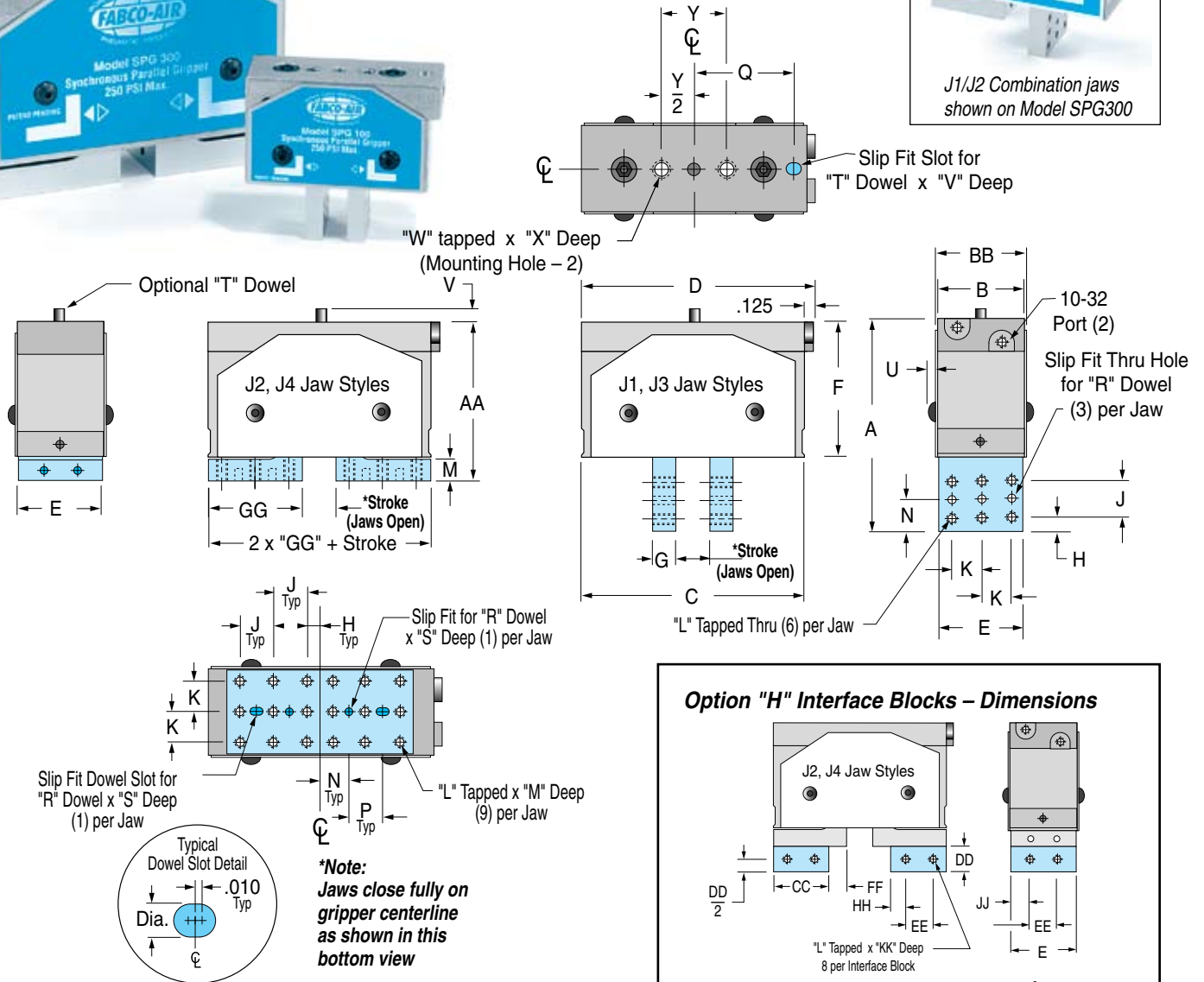

Gripper Dimensions

Models SPG 100, SPG 200, SPG 300, SPG 300LS, SPG 300HF, SPG 300LSHF																				
Model	Stroke	A	AA	B	BB	C	CC	D	DD	E	EE	F	FF	G	GG	H	HH	J	JJ	K
SPG 100	.25	1.750	1.375	.750	.81	1.875	.594	2.000	.250	.720	.375	1.156	.156	.187	.750	.094	.110	.281	.172	.250
SPG 200	.40	2.250	1.750	.990	1.05	2.625	.875	2.750	.375	.960	.500	1.469	.250	.235	1.125	.125	.187	.437	.230	.312
SPG 300	.54	3.125	2.531	1.312	1.38	3.500	1.125	3.625	.500	1.281	.625	2.129	.375	.355	1.500	.187	.250	.562	.328	.468
SPG 300LS	1.16	"	"	"	"	4.125	"	4.250	"	"	"	"	"	"	"	"	"	"	"	"
SPG 300HF	.54	"	"	"	"	4.750	"	3.625	"	"	"	"	"	"	"	"	"	"	"	"
SPG 300LSHF	1.16	"	"	"	"	6.000	"	4.250	"	"	"	"	"	"	"	"	"	"	"	"

Small to Mid-Size Gripper Models

SPG 300HF High Force Models



Note: Jaw detail dimensions on this page are identical to SPG300 dimensions shown on page 8.

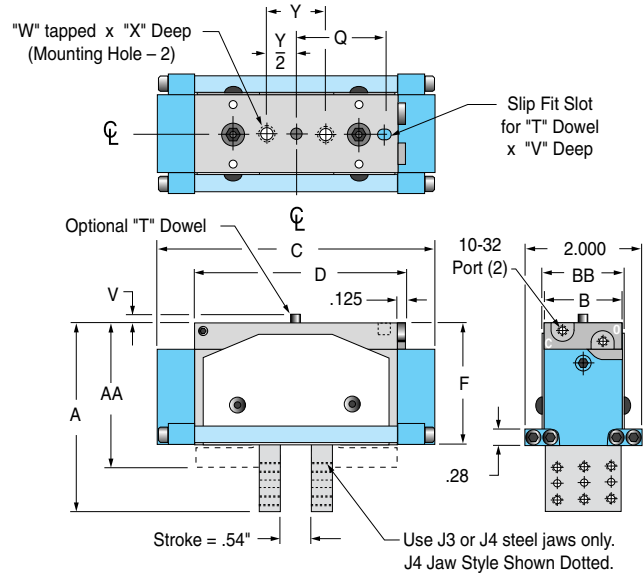

SPG 300LS Long Stroke Models

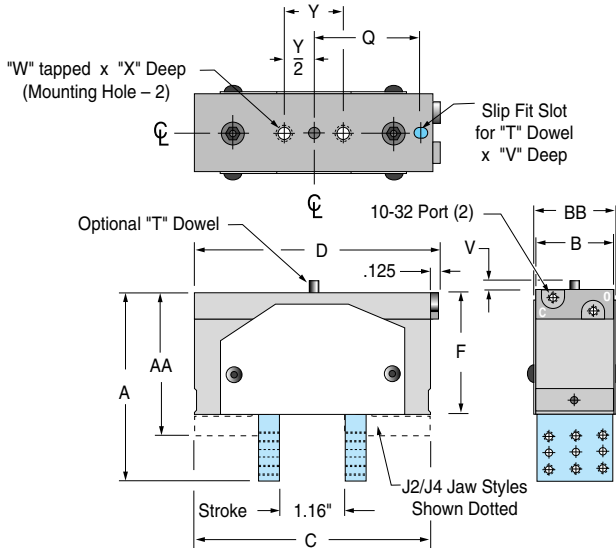

SPG 300LSHF Long Stroke, High Force Models

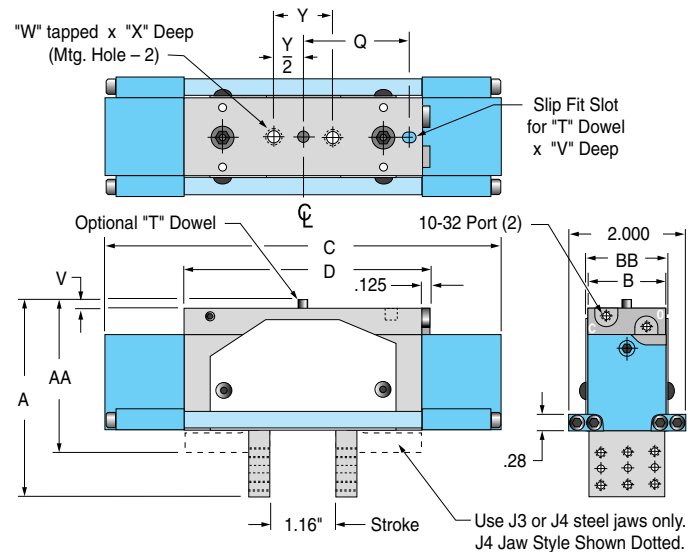

Models SPG 100, SPG 200, SPG 300, SPG 300LS, SPG 300HF, SPG 300LSHF														
Model	KK	L	M	N	P	Q	R	S	T	U	V	W	X	Y
SPG 100	.25	#4-40	.187	.235	.281	.875	3/32	.10	1/8	.06	.09	#8-32	.31	.562
SPG 200	.35	#6-32	.235	.344	.438	1.125	1/8	.16	3/16	.06	.16	#10-24	.38	.875
SPG 300	.50	#8-32	.340	.469	.562	1.500	1/8	.16	3/16	.07	.18	1/4-20	.40	1.000
SPG 300LS	"	"	"	"	"	1.812	"	"	"	"	"	"	"	"
SPG 300HF	"	"	"	"	"	1.500	"	"	"	"	"	"	"	"
SPG 300LSHF	"	"	"	"	"	1.812	"	"	"	"	"	"	"	"

Weight with Aluminum Jaws	for Steel Jaws add	Model
0.2 lbs	.08 lbs	SPG 100
0.5 lbs	.18 lbs	SPG 200
1.2 lbs	.40 lbs	SPG 300
1.4 lbs	"	SPG 300LS
1.6 lbs	"	SPG 300HF
1.9 lbs	"	SPG 300LSHF

"SPG" Series Parallel Grippers

SPG 600 Basic Models



Model SPG600 shown for size comparison with Models SPG100 (left) and SPG300

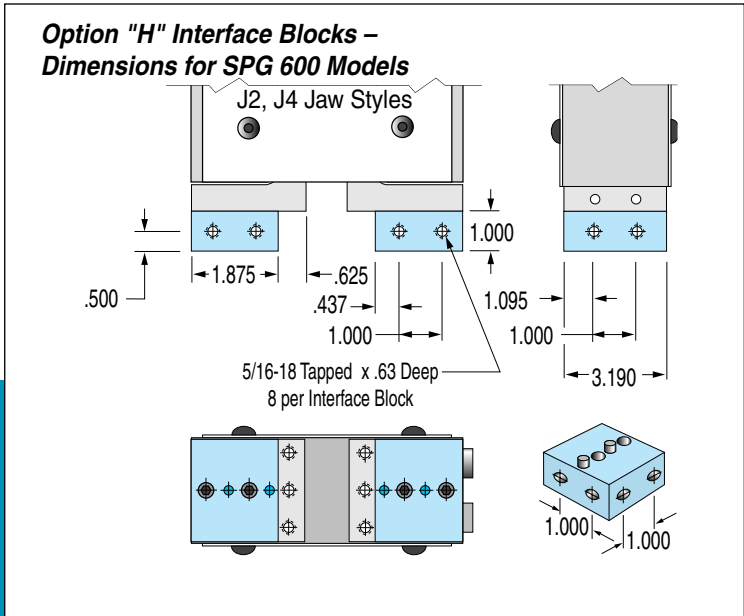
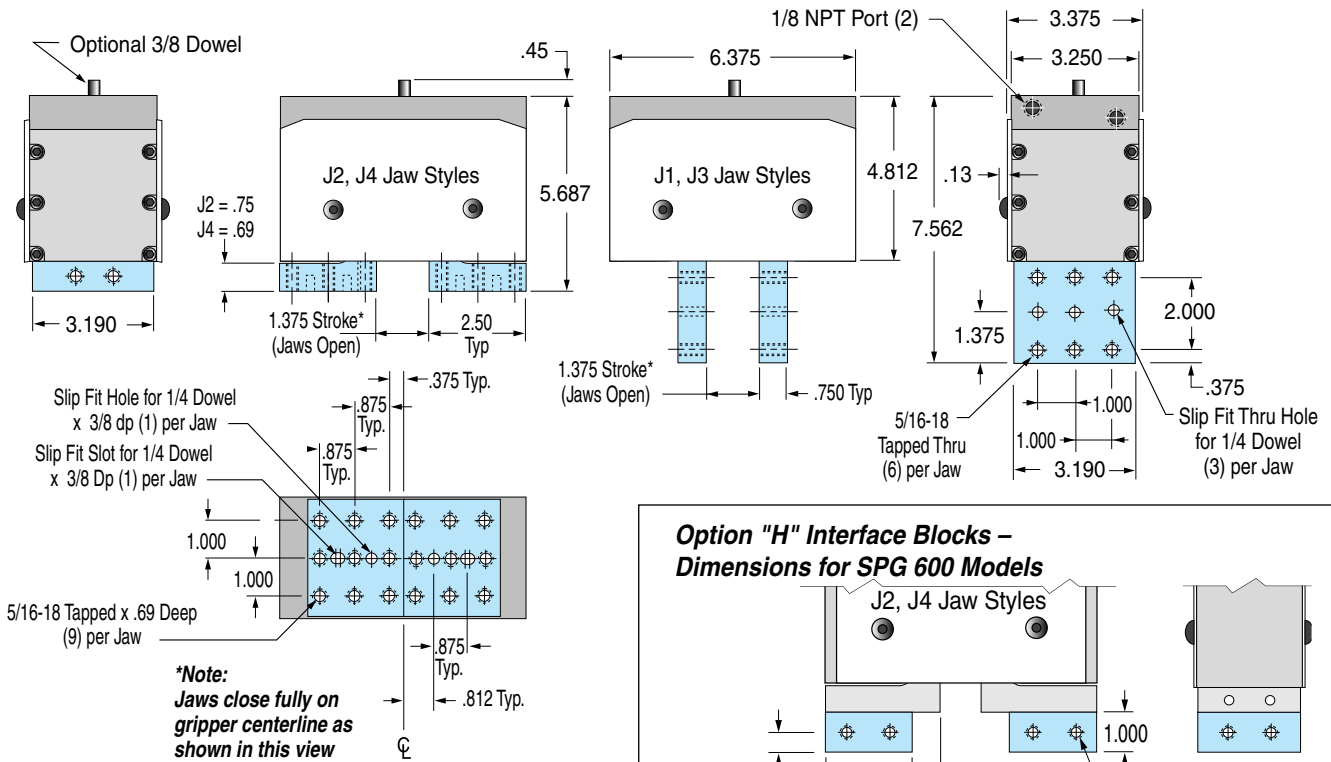
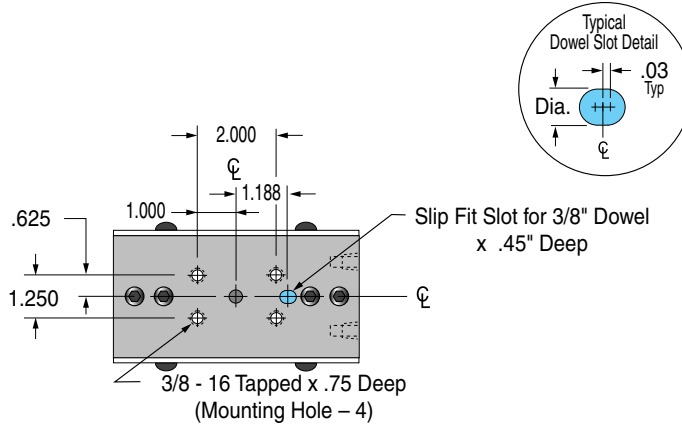

Large Size Models

SPG 600HF High Force Models

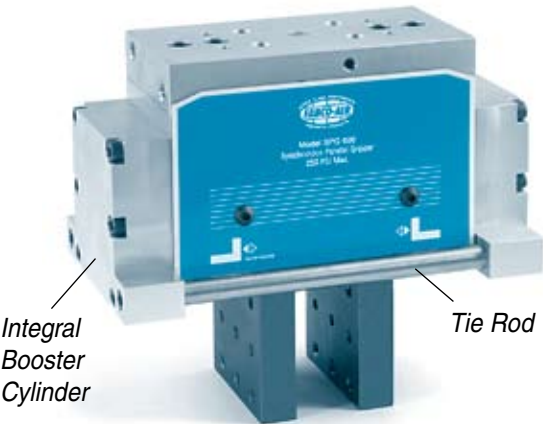

Note: Jaw detail dimensions on this page are identical to jaw dimensions shown on page 10.

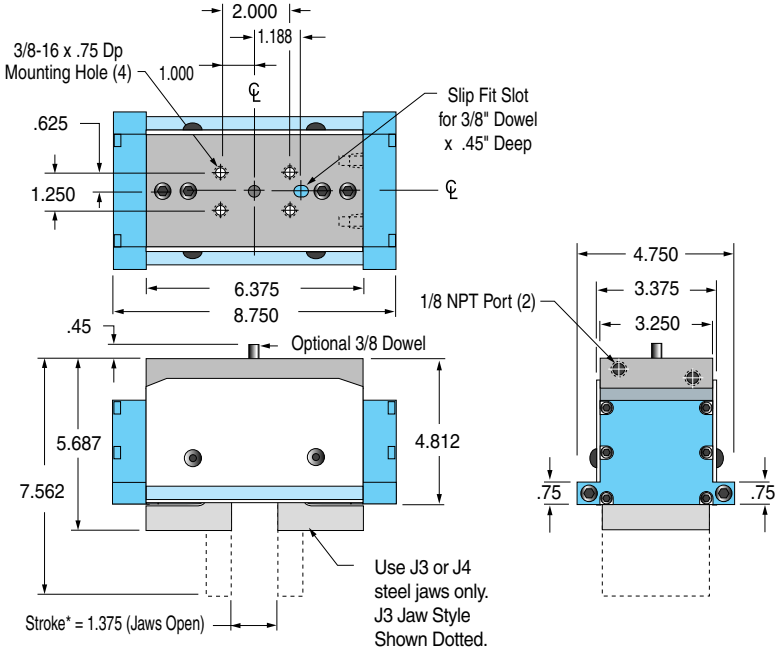

SPG 600LS Long Stroke Models

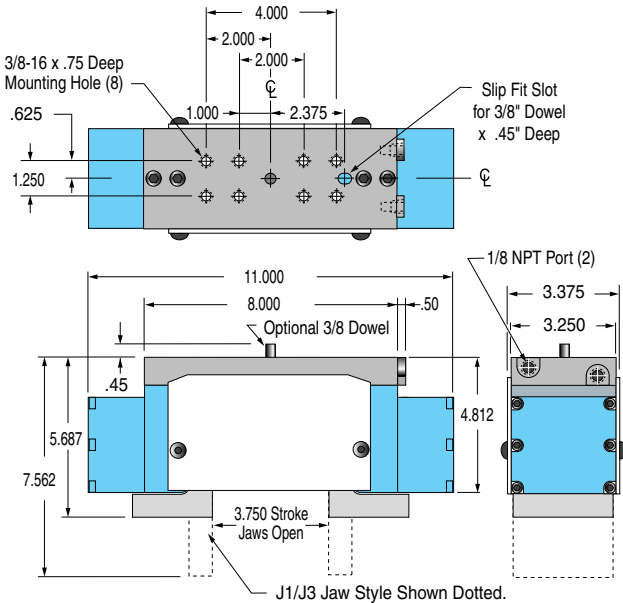

SPG 600LSHF Long Stroke, High Force Models

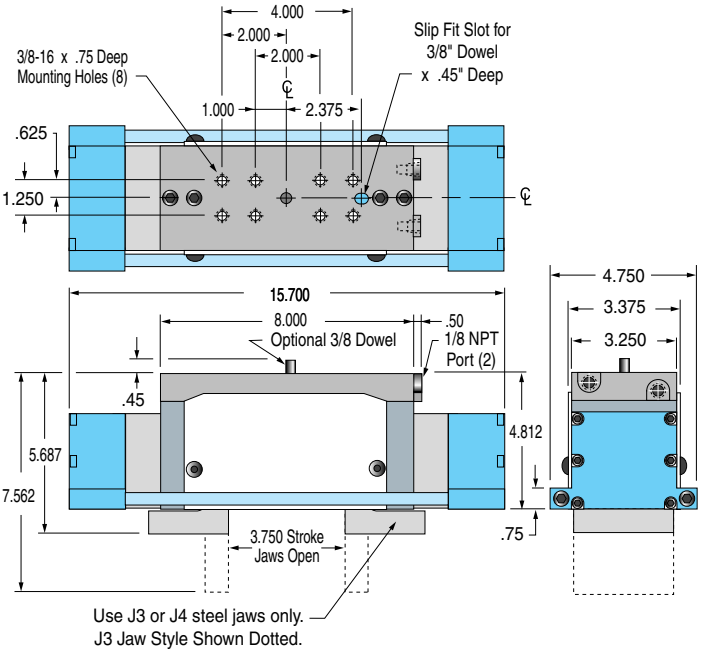

Gripper Weights

Model	Weight with Aluminum Jaws	for Steel Jaws add
SPG600	10.5 lbs	5.1 lbs
SPG600LS	13.7 lbs	5.1 lbs
SPG600HF	13.3 lbs	5.1 lbs
SPG600LSHF	20.3 lbs	5.1 lbs

“SPG” Series Parallel Grippers



Long Stroke Model SPG300LS shown with face mounted proximity switches. Mounting bracket has convenient slot to channel wiring to the side of gripper.

Proximity Switches – Option Codes S01 - S04

All SPG Gripper models are available with rectangular body proximity sensors attached to the face of the gripper by a tee slot bracket. Switches are actuated by sensing a pin on one jaw. Single and dual position sensors are available for verifying open/close/both jaw positions.

Specials – Because SPG Grippers are symmetrical, a third switch can be added on the opposite side to detect parts presence. If jaws “overtravel” the grip point, the third switch is actuated signaling that no part was present to “stop” the jaw travel. (Call our applications department for details.)

Note: These sensors are extremely sensitive and can make and break dual switches with as little as .025” jaw travel!

Sensors can be mounted with the leadwires adjacent to the port, allowing the air supply tubing and sensor wires to be neatly bundled together. Or, the wires can be routed to exit on the side opposite the ports.

Proximity Switches – Option Codes S11 - S20

SPG 200 and 300 models (except High Force) with “J2” or “J4” jaw styles can be ordered with an alternate prox switch option utilizing a 5mm threaded body. Switches are mounted on either end of the gripper and are actuated by sensing the head of cap screws attached to the jaw end(s).

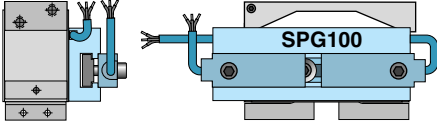
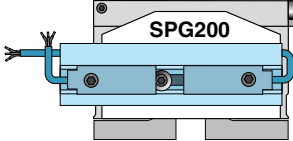
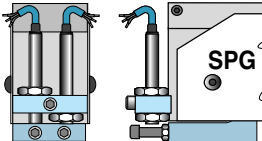
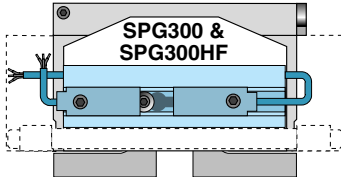
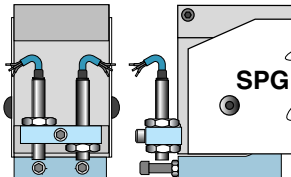
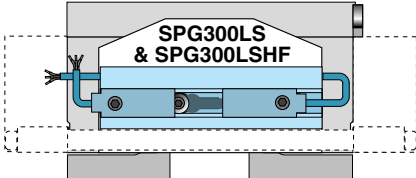
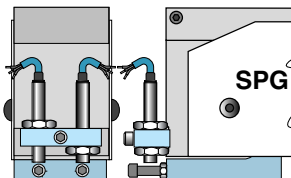
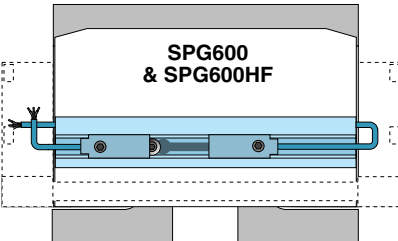
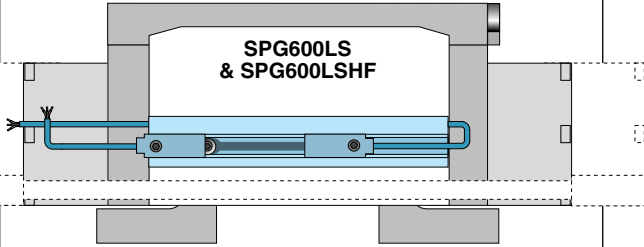

Code S19 or S20 – Dual 5mm threaded body prox switches shown on Model SPG200

Sensing Options S01 – S05	Sensing Options
	<p>5mm Proximity switches are not available on the Model SPG 100</p>
	
	
	
	<p>5mm Proximity switches are not available on the Model SPG 600</p>
	<p>5mm Prox switches are not available on Model SPG 600LS</p>

The unique grippers offering an extensive choice of sensors!

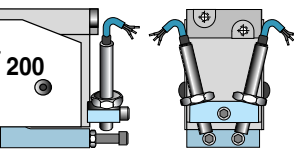
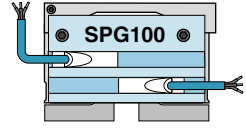
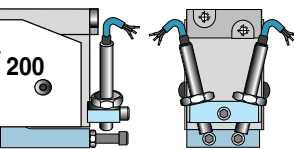
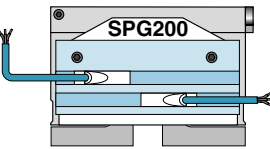
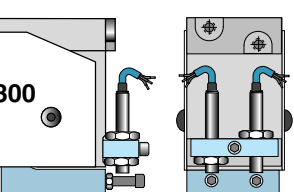
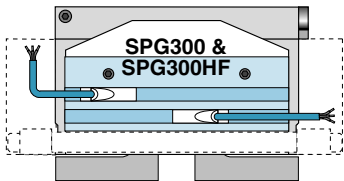
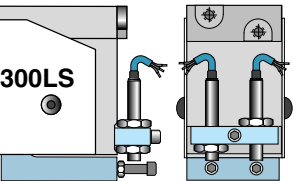
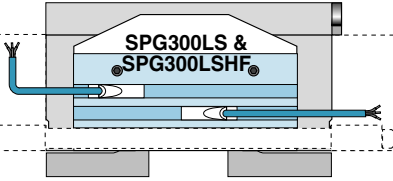
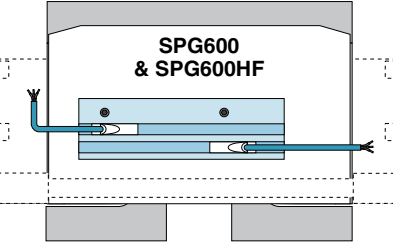
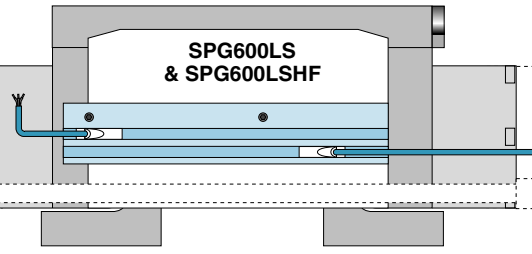
S11 – S20	Sensing Options E20– E30
	
	
	
	
	
	



Model SPG300 shown with Code E23C or E24C face mounted, quick-disconnect, electronic sensors.

Electronic Sensors – Option Codes E20–E24
Magnetic Reed Switches – Option Codes E25–E30
 All SPG Grippers are available with electronic sensors or reed switches that are clamped on a bracket mounted on either face of the gripper. These are actuated by a magnet attached to one jaw. Single and dual position sensors are available for verifying open/close/both jaw positions.

Specials – Brackets can be mounted on both faces to accommodate three or four sensors or switches. See "Special Examples 1 & 3" on page 5.

Prewired Style Switches: Codes E21 - E30
 Prewired styles are supplied with 9 foot leadwire.

Quick Disconnect Style Switches: Codes E21C - E30C
 Quick disconnect style switches are supplied with 6" pigtail with male connector. Order female connector cordsets separately as follows:

- CFC-1M 1 meter
- CFC-2M 2 meters
- CFC-5M 5 meters

See "How to Order" guide on page 7.

"SPG" Series Parallel Grippers

Center Locating Dowel Pin - Option "A"

Dowel pin facilitates precision mounting.

Mounting method (1)

Machine a slip fit channel .030" deep into customer's tooling to accept Gripper dimension "B". Mounting the gripper is accomplished by "slipping" the gripper's

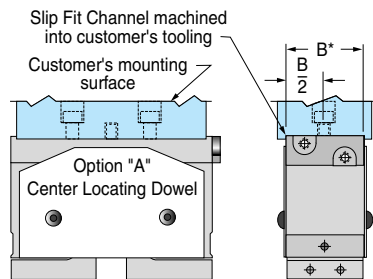

dowel into a slip fit dowel hole and pushing the gripper into the machined channel. Removal is easy and does not require "prying" the gripper off two "stuck" dowel holes. (See dimensions pages 8-11)

Mounting Method (2) Utilizes the slip fit dowel slot that is included with the center locating dowel pin. The center dowel pin establishes gripper centerline on an X-Y plane. The end dowel locates the X Axis

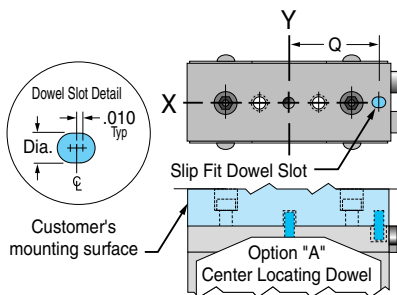

preventing rotation. The "Q" dimension is not critical. It can be held to $\pm .005$ and still provide precision engagement in the gripper dowel slot.

Ports Front & Rear - Option "B"

End ports are plugged. Not available on SPG100, SPG600, or Long Stroke Models.

Bumper Options "C", "D" & "E" (Not available on SPG100 Models) For quiet, high speed cycling - or for Adjustable Stops

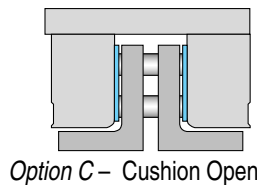

Option C - Cushion Open

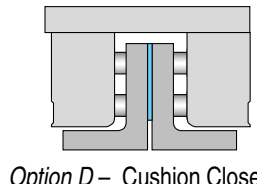

Option D - Cushion Close

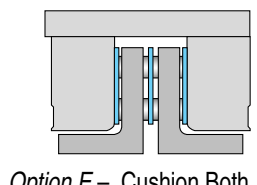

Option E - Cushion Both

Quiet, high speed cycling - The SPG is the only gripper in its class to offer bumpers (both extend and retract) for quiet, high-speed cycling. Urethane pads (1/32" thick, except SPG600 1/16" thick) can be installed against the outside of the jaws for cushioning at the "open" position - or one pad in the center can be used to cushion the "closed" position. Available on SPG200 and larger models for "open", "closed" or "both" positions.

Adjustable Stops - By simply "stacking" the bumper pads, custom strokes can be achieved in 1/32" increments (1/16" on SPG600). This is an ideal way of limiting stroke length when high speed cycling is desired with the minimum amount of time consuming stroke.

To order, specify the number of pads to be "stacked" at the open and/or closed position as follows:

C3 = three pads on each side for open
D2 = two pads in between jaws for close.

Bumper Location
Quantity of Bumpers in Stack

Non-Synchronous Grippers Compliant Type - Option "N"

This configuration is provided by simply removing the rocker arm that normally provides synchronization. Jaws will comply to the centerline established by the part to be gripped. The combination of equal piston forces and internal friction prevents jaw drift.

Not available on SPG100 or High Force models.

The family of grippers offering the widest choice of options!

Spring Options - "F" & "G" (Not available on SPG100, Long Stroke, or High Force Models) For "Failsafe" or "Single Acting" Operation

Spring options can be used to maintain grip force with loss of air pressure (fail safe) or as single acting grippers (single air supply line to port).

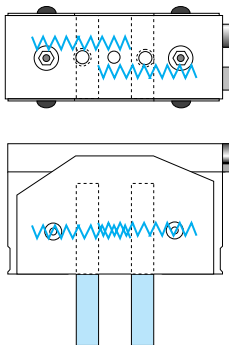

Also, springs can be used to "assist" gripping force.

Example: SPG 300 with "G" option would have a standard closing grip force of 22 pounds per jaw (at 100 psi as shown in the Gripper Selection Guide, page 6), plus a spring assist of 12 pounds per jaw at full open (reference the chart below), for a total of approximately 34 pounds per jaw gripping force.

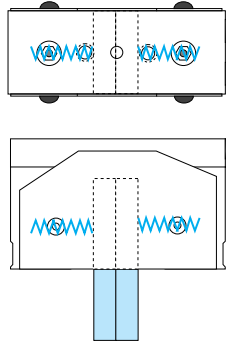

Spring Force Per Jaw To Open (Option F)		
Model	Spring Force @ Full Open	Spring Force @ Full Close
SPG200	3.8 lbs	4.9 lbs
SPG300	7.4 lbs	12.0 lbs
SPG600	35.0 lbs	70.0 lbs

Spring Force Per Jaw To Close (Option G)		
Model	Spring Force @ Full Close	Spring Force @ Full Open
SPG200	3.5 lbs	5.3 lbs
SPG300	7.1 lbs	12.0 lbs
SPG600	33.0 lbs	63.0 lbs

Non-Synchronous Grippers Fixed Reference Type - Option "P" (J2 & J4 Jaw Styles Only)

Jaws operate completely independently thru 2 sets of ports (2 air valves required). One jaw is fitted with an adjustable stop for fixed reference point. Fixed reference jaw requires 50% more pressure than its mating jaw.

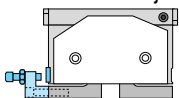

Not available on SPG100 or High Force models.

Interface Blocks - Option "H"

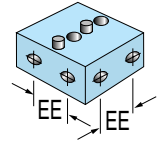

Interface blocks can be attached to J2/J4 jaws allowing tooling to be mounted on any side of the block. See "problem #2, solution C" on page 4. Dimensions are on pages 8 & 10.

Strain Relief - Option "R"

Air tubing is held by slotted clamps attached to the face of the gripper. **Not available on SPG600 or High Force models.**



Viton Seals - Option "V"

High temperature seals

Escapement Device - Option "Q"

(J2 & J4 Jaw Styles Only)

Same as Option "P" except that both jaws have adjustable stops and operate on equal pressure. See "Special Example #3 on page 5 for details. **Not available on SPG100 or High Force models.**

"GR" & "GS" Series Angular Grippers

Operational Features

- Grip force easily adjusted by varying input pressure.
- **External adjustment of final "Jaw Open" and "Jaw Close" positions can be made while the gripper is mounted, pressurized and operational. Disassembly is not required.**
- Gripper body is marked "0" at open adjustment screw and marked "1" at close adjustment screw
- Hardened parts and locking threads provide "stay put" adjustment.
- Operating pressure 15 to 150 psi
- Air or hydraulic service

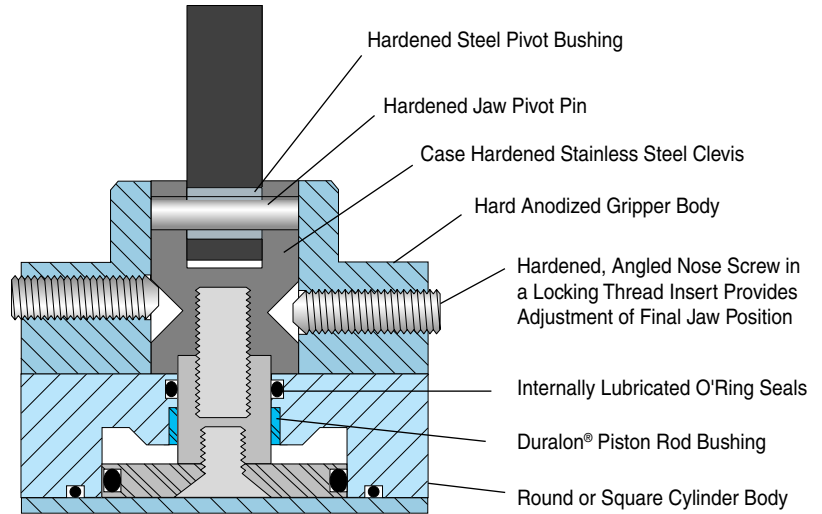

Selection Guide

GS Series – Miniature Style



GS21 Style – 01 Size

- Models** • GS21: 2-Jaw Angular Gripper
- Jaws** • Blank Rectangular Jaws 1", 1 1/2" and 2" long
- Mounting Hole Jaws
- Mounting** • Threaded Nose Mount
- Side mount (2 surfaces)
- Options** • Viton Seals

GR Series – Round Body Style

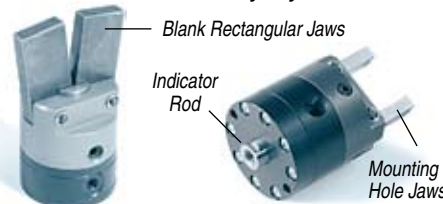

GR21 Style

GR22 Style

- Models** • GR21: 2-Jaw Angular Gripper
- GR22: 2-Jaw Angular Gripper with Indicator Rod
- Jaws** • Blank Rectangular Jaws 1" to 5" long
- Mounting Hole Jaws • Make your own, or
- Custom Jaws from Fabco-Air to your specs.
- Mounting** • Face Mount (Only)
- Options** • Sensors • Viton Seals • PTFE Seals

GS Series – Square Body Style

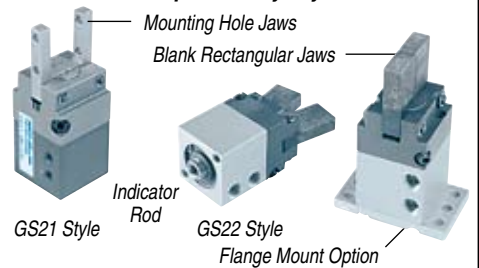

GS21 Style

GS22 Style

Flange Mount Option

- Models** • GS21: 2-Jaw Angular Gripper
- GS22: 2-Jaw Angular Gripper w/Indicator Rod
- Jaws** • Blank Rectangular Jaws 1" to 5" long
- Mounting Hole Jaws • Make your own, or
- Custom Jaws from Fabco-Air to your specs.
- Mounting** • Face & Side Mount (Both Included Standard)
- Options** • Sensors • Viton Seals • Flange Mount

To Determine Grip Force Use the formula and chart data shown below

$$\frac{\text{Pressure (psi)} \times (\text{Power Factor from Chart})}{\text{Grip Length (Inches – Grip Point to Jaw Pivot)}} = \text{Force (Pounds)}$$

Chart shows power factors for gripping the part from its outside – and from its inside. The result is theoretical static grip force and does not account for inertial loading, pressure fluctuations, external friction, etc.

Gripper Power Factors

Gripper Model	Grip Force On Part	Gripper Size Code (Cylinder Bore Size)							
		Mini-Style	Standard Round Body & Square Body Styles						
		-01 (3/8")	-02 (1/2")	-04 (3/4")	-06 (7/8")	-10 (1 1/8")	-20 (1 5/8")	-30 (2")	-50 (2 1/2")
GR21	Outside	–	.045	.144	–	.396	1.386	2.727	5.022
GR21	Inside	–	.063	.171	–	.504	1.629	3.177	5.517
GR22	Outside or Inside	–	.045	.144	–	.396	1.386	2.727	5.022
GS21	Outside	.020	–	–	.207	.396	1.188	2.430	–
GS21	Inside	.024	–	–	.243	.504	1.395	2.790	–
GS22	Outside or Inside	Not Available	–	–	.207	.396	1.188	2.430	–

Air Operated for External or Internal Gripping

How to Order

Series	Model
GR Round Body	21 – Air Open; Air Close
	22– Air Open; Air Close w/Indicator Rod
	23– Spring Open; Air Close (Requires additional body length. Please consult factory for details.)
	24– Spring Open; Air Close w/Indicator rod
	25– Air Open; Spring Close
26– Air Open; Spring Close w/Indicator rod	
GS Square Body	21 – Air Open; Air Close
	22– Air Open; Air Close w/Indicator Rod

Gripper Size Code			
Round Body		Square Body	
Code	Bore	Code	Bore
-02	1/2"	-01	3/8"
-04	3/4"	-06	7/8"
-10	1 1/8"	-10	1 1/8"
-20	1 5/8"	-20	1 5/8"
-30	2"	-30	2"
-50	2 1/2"		

Other Options
F7 – Flange Kit (GS Series only) Note: There are two flange styles for size –30 GS grippers.
F8 Consult table on page 19 for dimensions and specify either F8 or F9. To order flange kits separately, see kit numbers in the same table.
T – PTFE Seals (GR Series only)
V – Viton Seals

EXAMPLE

GR21 – 10

Model

– 130

Jaw style

– E21

Sensor options

– V

Other options

Jaw Styles	
-000	None - Customer to furnish Jaws. Pivot details shown on next page.
	<i>Length</i>
-110	Blank Rectangular Jaws 1"
-115	Blank Rectangular Jaws 1 1/2"
-120	Blank Rectangular Jaws 2"
-130	Blank Rectangular Jaws 3"
-140	Blank Rectangular Jaws 4"
-150	Blank Rectangular Jaws 5"
	(Note: Jaw length + .15" –.00)
-200	Jaws with Mounting Holes
-xxx	Custom Jaws - Fabco-Air will build to your specs – or design and build to your requirements

Sensing Options	
Electronic Sensor Package	
Electrical Characteristics – LED, 6-24 VDC, 0.20 Amp Max, 0.5 Voltage Drop	
E20 Sensor Package without sensors	
E21, E21C -Single sensor (PNP) sourcing	
E22, E22C -Single sensor (NPN) sinking	
E23, E23C -Dual sensor (PNP) sourcing	
E24, E24C -Dual sensor (NPN) sinking	
	
Gripper sizes GR-04, GS-06 and larger are available with electronic sensors actuated by a magnet on the cylinder piston. Requires additional body length. Please consult factory for details.	
Codes E21 - E24 prewired styles are supplied with nine foot leadwire.	
Codes E21C - E24C quick disconnect styles are supplied with 6 inch pigtail with male connector.	
Order female connector cordsets separately as follows:	
CFC-1M.....	1 meter
CFC-2M.....	2 meters
CFC-5M.....	5 meters

Ordering Example 1: GR21 – 04 – 130



(Code – 130) Blank Rectangular 3" Jaws

(GR21) Round Body 2 Jaws Angular

(Code – 04) Cylinder Bore 3/4"

Ordering Example 2: GS22 – 06 – 110 – V

(GS22) Square Body
2 Jaws Angular
with Indicator Rod

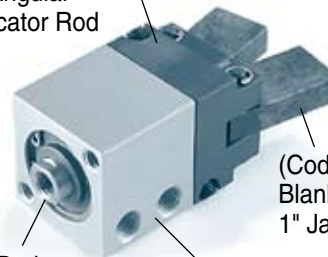

(Code – 110)
Blank Rectangular
1" Jaws

Indicator Rod

(Code – 06)
Cylinder Bore 7/8"

(Code – V)
Viton Seals

"GR" & "GS" Series Angular Grippers

"GR" Round Body Series

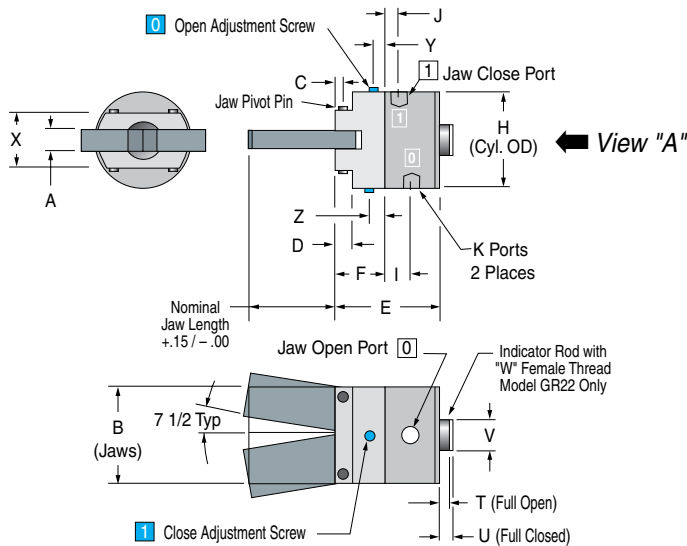

Note: Model GR23 requires additional body length. Please consult factory for details.

Size -02 (View "A")

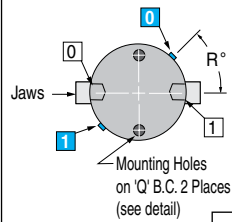

Sizes -04, -10, -20 (View "A")

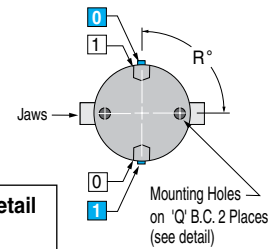

Size -30 (View "A")

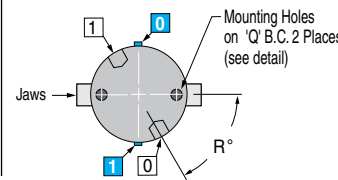

Size -50 (View "A")

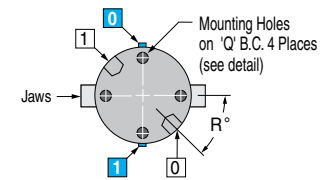

Gripper Jaws – Round Body dimensions charted below; Square Body Dimensions charted below opposite page

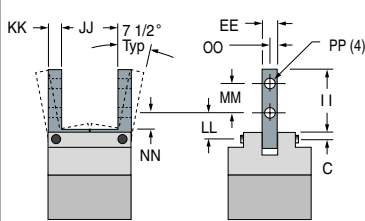

"GR & GS" Mounting Hole Jaws Dimensions

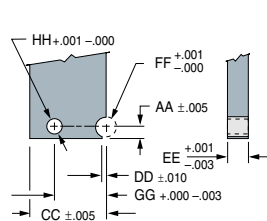

"GR & GS" Rectangular Jaw & Pivot Details

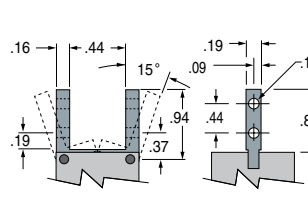

GS21-01 Miniature Series Mounting Hole Jaws

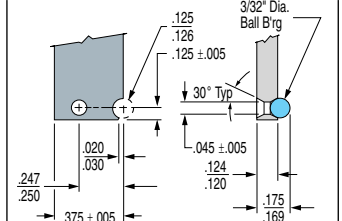

GS21-01 Miniature Series Rectangular Jaws

"GR" Series Dimensions

GR – Round Body Mounting Hole Jaw Dimensions												Weight per pair
Size	Bore	C	EE	II	JJ	KK	LL	MM	NN	OO	PP	
-02	1/2	.13	.19	1.06	.75	.16	.38	.625	.187	.09	.12	.5
-04	3/4	.16	.25	1.03	.75	.25	.41	.625	.187	.13	.14	1.0
-10	1 1/8	.22	.37	1.06	1.00	.25	.50	.625	.218	.19	.20	1.7
-20	1 5/8	.25	.50	1.50	1.50	.50	.69	.750	.312	.25	.27	5.7
-30	2	.25	.50	1.97	2.00	.50	.69	1.250	.312	.25	.27	7.5
-50	2 1/2	.38	.50	2.30	2.75	.50	.81	1.500	.312	.25	.27	10.5

GR – Round Body Rectangular Jaw and Pivot Details											Jaw Weight per pair OZ	
Size	Bore	AA	CC	DD	EE	FF	GG	HH	Base 1"	Add per 1"		
-02	1/2	.187	.56	.035	.185	.250	.375	.126	1.2	.9		
-04	3/4	.187	.75	.035	.248	.250	.453	.126	2.2	1.7		
-10	1 1/8	.218	1.00	.035	.373	.312	.562	.188	4.7	3.5		
-20	1 5/8	.250	1.38	.045	.500	.375	.875	.251	8.5	6.0		
-30	2	.280	1.63	.045	.500	.438	1.125	.251	9.9	6.9		
-50	2 1/2	.312	1.88	.062	.500	.500	1.250	.376	11.5	7.4		

GR – Round Body Gripper Dimensions																				Weight OZ without Jaws GR21 GR22						
Size	Bore	A	B	C	D	E _{GR21}	E _{GR22}	F	H	I	J	K	O	P	Q	R	S _{GR21}	S _{GR22}	T	U	V	W	X	Y	Z	
-02	1/2	.19	1.13	.13	.36	1.58	1.75	.88	1.13	*	.33	#10-32	#6-32	.19	.88	45°	.13	.14	.13	.19	.25	8-32x.25	.63	.22	3.0	3.5
-04	3/4	.25	1.50	.16	.39	1.70	1.87	1.00	1.50	*	.33	#10-32	#6-32	.19	1.19	90°	.13	.14	.13	.19	.31	10-32x.25	1.00	.20	6.5	7.0
-10	1 1/8	.38	2.00	.22	.40	1.94	2.28	1.06	1.99	.31	.31	1/8 NPT	#10-32	.38	1.69	90°	.19	.47	.14	.20	.50	5/16-24x.38	1.13	.25	11.0	13.5
-20	1 5/8	.50	2.75	.25	.56	2.38	2.85	1.38	2.74	.50	.50	1/8 NPT	#10-32	.38	2.38	90°	.19	.60	.14	.27	.62	3/4-24x.38	1.50	.33	24.5	30.5
-30	2	.50	3.25	.25	.56	2.44	3.07	1.38	3.24	.56	.38	1/8 NPT	1/4-20	.38	2.81	72°	.19	.75	.14	.27	.75	1/2-20x.40	1.50	.33	33.0	42.5
-50	2 1/2	.50	3.75	.38	.74	3.06	3.63	1.75	3.74	.75	.38	1/8 NPT	1/4-20	.50	3.25	45°	.19	.75	.14	.27	.75	1/2-20x.56	1.75	.33	55.5	66.5

Air Operated Open & Close for External or Internal Gripping

"GS" Square Body Series

GS Series – Miniature Style

Mounting Brackets

Note: 4 Mounting Holes on side surfaces are 6-32 x .16 deep

Part No: BRK-201

Part No: BRK-202

Weight = 2.3 ounces without jaws

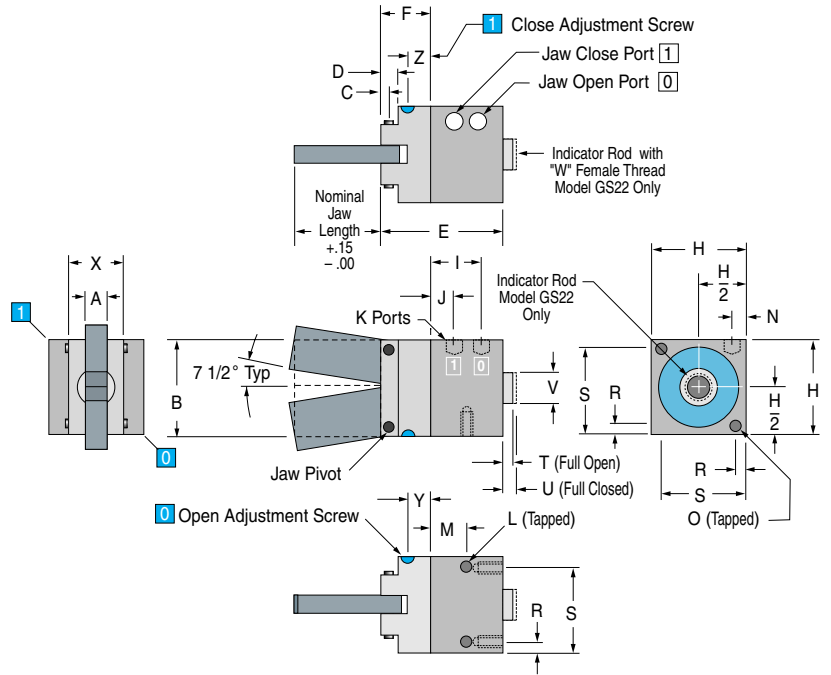

Custom Jaws –

Fabco-Air will build to your specs –or will design and build to your application requirements.



Flange Kit Style 7

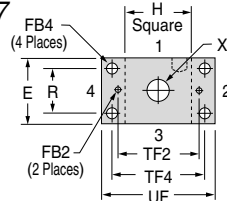

Flange Kit Style 8 & 9

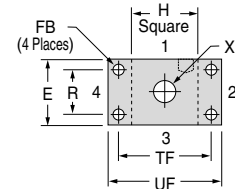

GS – Square Body Gripper Flange Kits

Size	Bore	Flange Style	Flange Kit No.	E	FB	FB2	FB4	H	R	TF	TF2	TF4	UF	X	Weight Oz.
-06	7/8	7	G7-06	1.50	NA*	.22	.22	1.25	1.00	NA*	1.75	2.00	2.50	.38	1.5
-10	1 1/8	7	G7-121	1.50	NA*	.22	.22	1.50	1.00	NA*	2.00	2.00	2.50	.56	1.4
-20	1 5/8	7	G7-221	2.00	NA*	.22	.31	2.00	1.43	NA*	2.50	2.75	3.38	.69	3.8
-30	2	8	G8-321	2.50	.38	NA*	NA*	2.50	1.84	3.38	NA*	NA*	4.13	.81	5.8
		9	G9-321	2.50	.28	NA*	NA*	2.50	2.00	3.00	NA*	NA*	3.50	.81	4.1

"GS" Series Dimensions

GS – Square Body Mounting Hole Jaw Dimensions

Size	Bore	C	EE	II	JJ	KK	LL	MM	NN	OO	PP	Weight per pair
-01	3/8	See drawing in "Gripper Jaws" Box opposite page										0.3
-06	7/8	.16	.25	1.03	.75	.25	.41	.625	.187	.13	.14	1.0
-10	1 1/8	.22	.37	1.06	1.00	.25	.50	.625	.218	.19	.20	1.7
-20	1 5/8	.25	.50	1.50	1.25	.38	.69	.750	.312	.25	.27	4.2
-30	2	.25	.50	1.97	1.50	.50	.69	1.250	.312	.25	.27	6.8

GS – Square Body Rectangular Jaw and Pivot Details

Size	Bore	AA	CC	DD	EE	FF	GG	HH	Jaw Weight per pair OZ		
									Base 1"	Add per 1"	
-01	3/8	See dwg in "Gripper Jaws" Box opposite page								0.6	0.4
-06	7/8	.187	.625	.035	.248	.250	.453	.126	2.2	1.7	
-10	1 1/8	.218	.750	.035	.373	.312	.562	.188	4.7	3.5	
-20	1 5/8	.250	1.000	.045	.500	.375	.750	.251	6.9	4.6	
-30	2	.280	1.250	.045	.500	.438	1.000	.251	8.7	7.0	

GS – Square Body Gripper Dimensions

Size	Bore	A	B	C	D	E	F	H	I	J	K	L	M	N	O	R	S	T	U	V	W	X	Y	Z	Weight OZ without Jaws	
																									GS21	GS22
-06	7/8	.25	1.25	.16	.39	2.16	1.00	1.25	.77	.39	#10-32	10-24x.25	.58	.31	1/4-20x.31	.19	1.06	.13	.21	.31	10-32x.25	1.00	.20	.34	6.14	6.54
-10	1 1/8	.38	1.50	.22	.40	2.47	1.06	1.50	1.02	.39	1/8 NPT	10-24x.25	.70	.28	1/4-20x.38	.19	1.31	.19	.27	.50	5/16-24x.38	1.13	.25	.44	10.0	11.1
-20	1 5/8	.50	2.00	.25	.56	3.07	1.38	2.00	1.16	.54	1/8 NPT	1/4-20x.31	.85	.31	1/4-20x.44	.25	1.75	.19	.27	.62	3/8-24x.38	1.50	.33	.52	22.4	25.2
-30	2	.50	2.50	.25	.56	3.24	1.38	2.50	1.24	.62	1/8 NPT	5/16-18x.38	.93	.38	5/16-18x.50	.25	2.25	.19	.32	.75	1/2-20x.40	1.50	.33	.52	32.0	37.5

“LPG” Series Parallel Grippers

Operational Features

Toolbars

extend toward and retract away from each other while maintaining absolute parallelism.

Stainless Steel Guide Shafts (4)

Integral Tube and Tie Rod Cylinder

Metal Covers (2)

Mounting Styles

MH1 – Through hole (4)
MH2 – Tapped hole (4)
Can be mounted with port side up or down.

Cross Tapped Holes

on each toolbar allows tooling mounting on any surface of the toolbars.

Frelon® Linear Bearing (8)

Double Rack & Pinion

(factory lubricated)
transfers force from inboard pair of guide shafts to the outboard pair for precise, synchronous motion.

Sealed Ball Bearings

How it works

The LPG Gripper shown above is an adaptation of Fabco-Air's EZ Series linear slides. Its jaws are a pair of toolbars which extend to the front away from the gripper mechanism (TBF tooling style).

An integral, double acting air cylinder drives the shorter toolbar and inboard pair of guide shafts. A double rack and pinion arrangement transfers force to the outboard guide shafts holding the wider toolbar. The toolbars (jaws) extend toward and retract away from each other with absolute parallelism and precise synchronous motion.

High Load Carrying Capacity

Bearings in the LPG Gripper have a very high load carrying capacity so that load is only limited by the strength of the guide shafts to resist deflection. Centering is accurate to within .002" repeatability, providing virtually "play free" gripping. Side-to-side play is less than .002".

Choice of Mounting Styles

The LPG Gripper can be mounted with the port side up or down because the end caps are machined on both the top and bottom surfaces. The end caps are available with through holes (Code MH1) or tapped mounting holes (Code MH2).

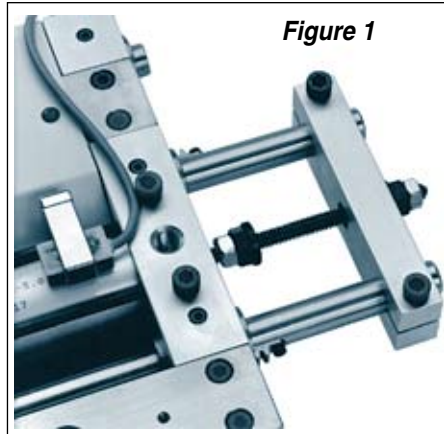

Figure 1

Mounting Note:

The LPG Gripper should be mounted to a flat plate at least as wide and as long as the gripper end caps. All four bolt holes must be used to secure the unit and maintain end cap alignment. Covers are mounted on the side opposite the mounting surface. Mounting surface shields the bottom side of the rack and pinion.

Sensors

The LPG Gripper is available with a magnetic band on the piston and several types of magnetically operated tie rod mounted sensors. Reed switches and electronic sensors are offered in pre-wired and quick disconnect styles.

Optional Dowel Holes for End Cap and Toolbar Mounting Surfaces

Dowel hole & slot option provides convenient and precise mounting of LPG Gripper end caps as well as attachment of tooling to the toolbars.

Adjustable Stops

The stop (Figure 1) consists of a single threaded rod with flange and lock nuts at each end. When both toolbars are up front (TBF tooling style), a clamp bar is added to the inboard guide shafts at the rear to stop against the flange nuts.

When a toolbar is mounted at both ends (TFR tooling style), the threaded rod is placed through a clearance hole in the center of the rear toolbar.

Positioning toolbars front and rear allows large parts to be gripped and/or centered.

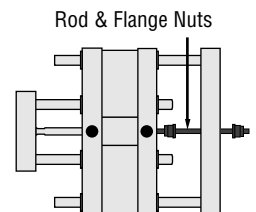

Bumpers

LPG Series Grippers are available with urethane bumpers for quieter operation. Bumpers must be used in conjunction with adjustable stops. A urethane washer is placed against each flange nut.

The exciting parallel gripper for large parts, long strokes

How to Order

Gripper Sizing Guide

Model	Guide Shaft Diameter	Bore	Stroke (Min)	Standard Stroke Lengths	Grip Force Per Jaw at 100 psi	
					Cyl Extend	Cyl Retract
LPG50	1/2"	1-1/8"	2"	2" to 12" by 2" increments	99 lbs	88 lbs
LPG75	3/4"	2"	4"	4" to 12" by 2" increments 16" to 24" by 4" increments	310 lbs	280 lbs

Stop Options

- 00 – No stop options desired
- 01 – Threaded rod with extend & retract flange stop nuts
- U1 – Type 01 Stop Package with Urethane Bumpers

EXAMPLE Model: **LPG50** Stroke: **- 8** End Cap Mounting Style: **- MH1** Integral options: **- V** Sensor Options: **- J73B** Tooling Style: **- TBF** Toolbar Options: **- B** Stop Options: **- 00**

End Cap Mounting Style

- MH1 – Through Mounting Holes
- MH2 – Tapped Mounting Holes

Integral Options

- D – Dowel hole & slot in endcaps
- V – Viton seals

Tooling Style

TBF – Toolbars Both in Front

TFR – Toolbars Front & Rear

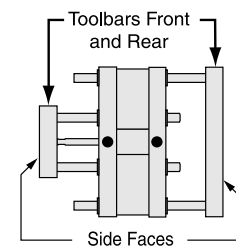
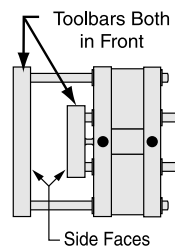

Toolbar Options

- B – Blank Toolbar (No mounting holes; no dowel holes)
 - D – Toolbar Dowel Holes & Slots located on top and side mounting faces
- See dowel hole & slot configurations on page 22 & 23.

Sensor Codes (Use "S000" if NO Sensors are desired)

Select a code for sensor type and indicate position in the box ().

Example: J73 B

- E = Cylinder extend position only
- R = Cylinder retract position only
- B = Both extend & retract positions
- *M = 3 sensors include E, R, and a mid-position
- *Note – Can be used for sensing parts presence

Electronic sensors & magnetic reed switches are actuated by a magnetic band on the piston.

Magnetic Piston & Clamp-On Sensors ("J")

Single sensor – 2" stroke minimum; Dual sensors – 4" stroke minimum.

9 Ft. Rewired	Quick Discon. w/5M cord set	Sensor Type	LED	Electrical Characteristics
J70 <input type="checkbox"/>	J71 <input type="checkbox"/>	Reed	Yes	5-120 VDC/VAC, 0.5 Amp Max, 10 Watt Max, SPST N.O., 3.5 Voltage Drop
J72 <input type="checkbox"/>	J73 <input type="checkbox"/>	Electronic	Yes	Sourcing PNP 6-24 VDC, 0.50 Amp Max, 1.0 Voltage Drop
J74 <input type="checkbox"/>	J75 <input type="checkbox"/>	Electronic	Yes	Sinking NPN 6-24 VDC, 0.50 Amp Max, 1.0 Voltage Drop

Magnetic Piston

- J800 Customer supplies the sensors and mounting clamps
- E800 Includes Dovetail Mounting Rail; customer supplies sensors

Magnetic Piston & Dovetail Style Sensors ("E")

For 2" Stroke & longer on all models

9 Ft. Rewired	Quick Discon. w/5M cord set	Sensor Type	LED	Electrical Characteristics
E70 <input type="checkbox"/>	E71 <input type="checkbox"/>	Reed	Yes	5-120 VDC/VAC, 0.03 Amp Max, 4 Watt Max, 2.0 Voltage Drop
E72 <input type="checkbox"/>	E73 <input type="checkbox"/>	Electronic	Yes	Sourcing PNP 6-24 VDC, 0.20 Amp Max, 0.5 Voltage Drop
E74 <input type="checkbox"/>	E75 <input type="checkbox"/>	Electronic	Yes	Sinking NPN 6-24 VDC, 0.20 Amp Max, 0.5 Voltage Drop
E76 <input type="checkbox"/>	E77 <input type="checkbox"/>	Reed	No	0-120 VDC/VAC, 0.5 Amp Max, 5 Watt Max, 0 Voltage Drop

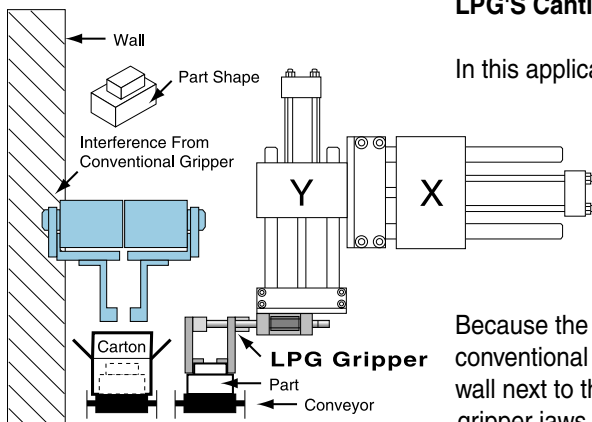

LPG'S Cantilevered Jaw Arrangement avoids interference

In this application an LPG Gripper is attached to a pick and place mechanism. "L shaped" fingers attached to the gripper jaws are positioned over a product conveyor in an automated shipping system. As each product passes under the gripper, the "L-shaped" fingers stop it. The fingers then grasp the product by clamping on its island area on top. Next the product is lifted, carried over to the carton positioned on the adjacent shipping conveyor, and placed inside.

Because the jaws must open perpendicular to the direction of conveyor travel, a conventional gripper (shown in blue) could not be used. It would interfere with the wall next to the carton conveyor. Only the LPG's cantilevered design permits the gripper jaws to be positioned as required without interference.

“LPG” Series Parallel Grippers

TBF Configurations (Toolbars Both in Front)

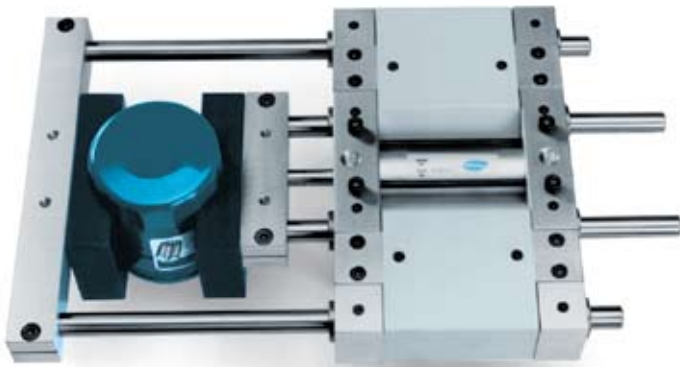

The **TBF** Configuration places the toolbars (jaws) in a cantilevered, or overhung arrangement, allowing the gripper jaws to be placed over the part to be gripped, while the body of the gripper is positioned clear of the part and its travel path.

Drawings show the LPG in its shortest possible stroke. In both TBF & TFR configurations these grippers cannot be manufactured with less stroke than shown in the charts below.

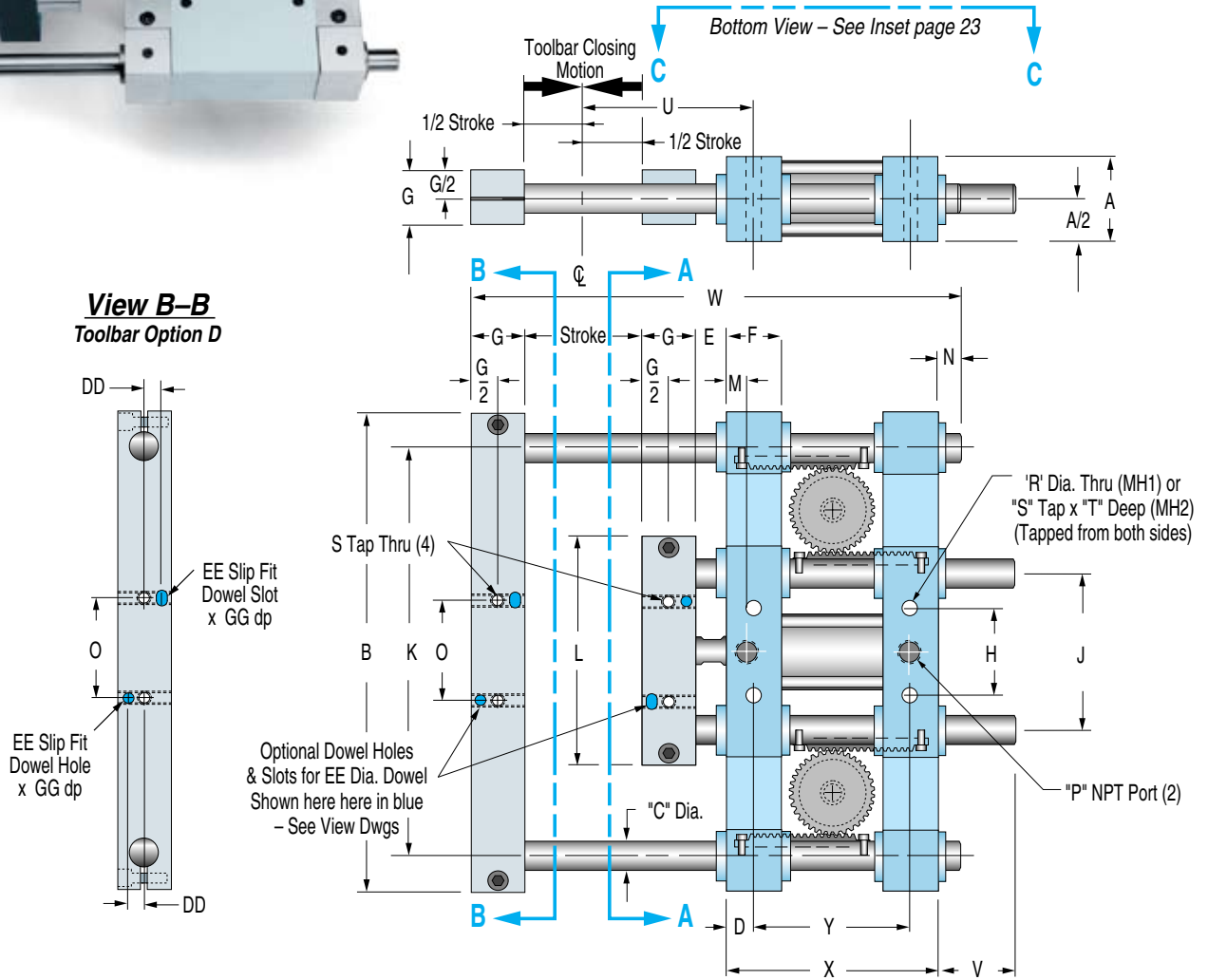

Gripper Dimensions

Models LPG 50 & LPG 75																								
Model	Stroke	A	B	C	D	DD	E	EE	F	FF	G	GG	H	HH	J	K	L	M	N	O	P	R	S	T
LPG 50	2" – 12"	1.470	8.38	.500	.50	.312	.50	3/16	1.00	1/4	1.00	.19	1.562	.25	2.750	7.125	4.00	.38	.38	1.750	1/8	.266	1/4-20	.62
LPG 75	4" – 24"	2.470	13.38	.750	.62	.500	.75	1/4	1.25	3/8	1.50	.25	2.750	.38	4.500	11.500	6.38	.50	.44	2.750	1/4	.406	3/8-16	1.00

Offering new levels of parts gripping versatility

TFR Configurations (Toolbars at Front & Rear)

The TFR Configuration places one toolbar (jaw) at the front and the other toolbar (jaw) at the rear, providing a "wide stance" jaw arrangement for gripping larger parts.

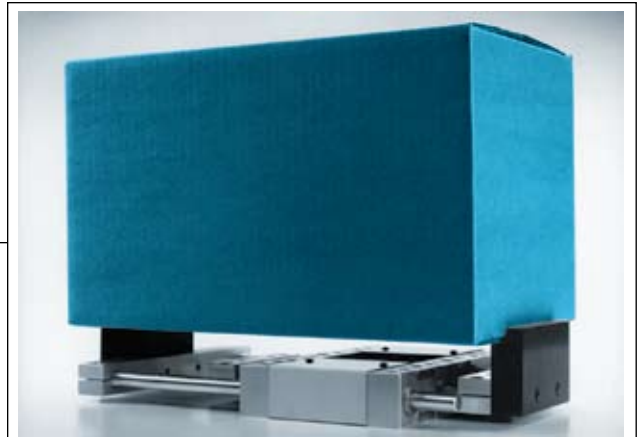

Pictured above is a special, dual-purpose LPG Gripper. The addition of a special rear toolbar provides "wide stance jaws (TFR)" for gripping the large carton shown. Standard "cantilevered jaws (TBF)" for smaller parts gripping can be seen beneath the carton to the left.

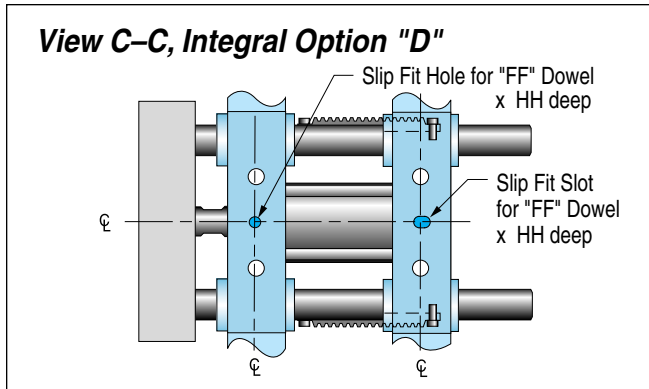

View A-A
Toolbar Option D

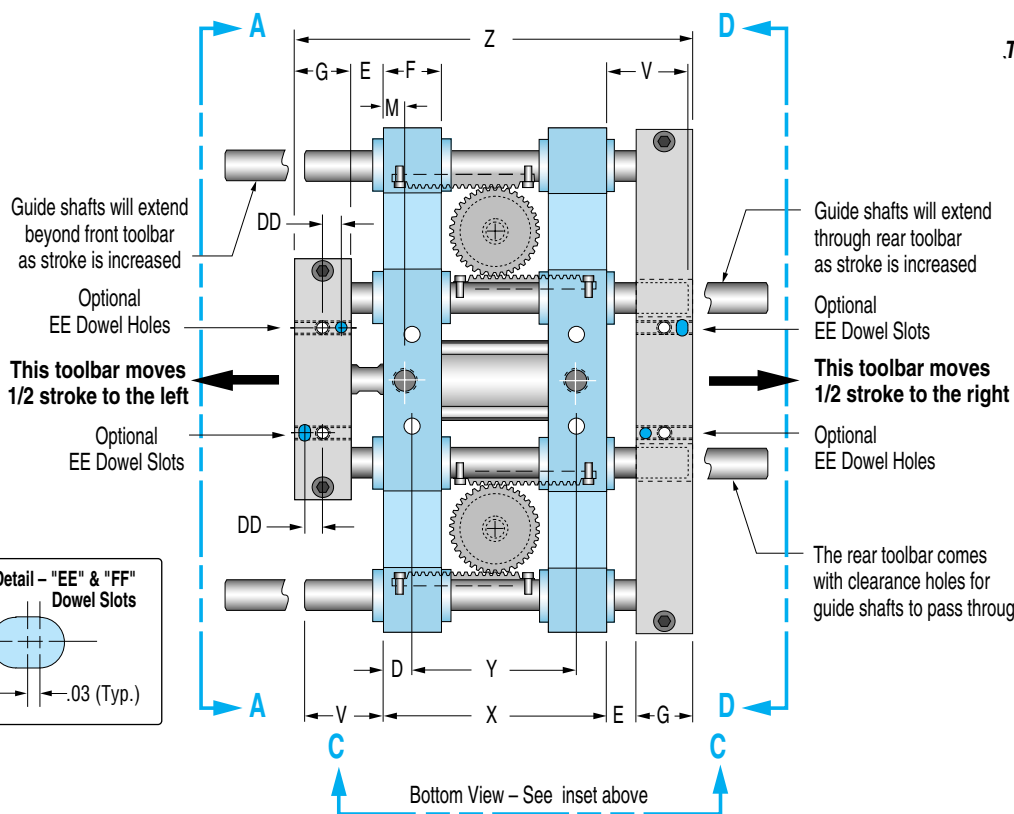
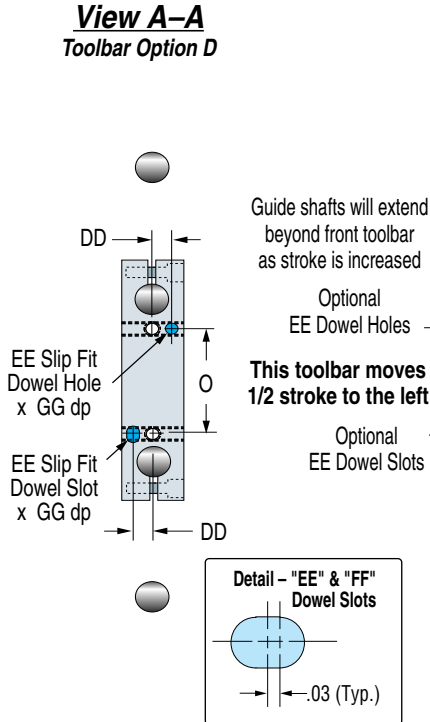

View D-D
Toolbar Option D

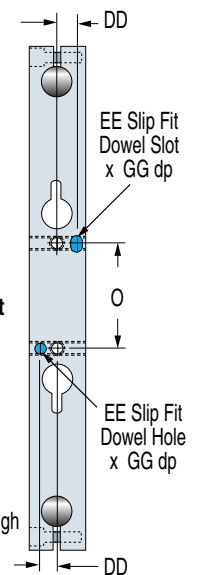

Model LPG 50 Standard Stroke Lengths						
	2.0	4.0	6.0	8.0	10.0	12.0
U	3.000	4.000	5.000	6.000	7.000	8.000
V	1.38	2.38	3.38	4.38	5.38	6.38
W	8.63	11.63	14.63	17.63	20.63	23.63
X	3.75	4.75	5.75	6.75	7.75	8.75
Y	2.750	3.750	4.750	5.750	6.750	7.750
Z	6.75	7.75	8.75	9.75	10.75	11.75

Model LPG 75 Standard Stroke Lengths								
	4.0	6.0	8.0	10.0	12.0	16.0	20.0	24.0
U	4.875	5.875	6.875	7.875	8.875	10.875	12.875	14.875
V	2.44	3.44	4.44	5.44	6.44	8.44	10.44	12.44
W	13.81	16.81	19.81	22.81	25.81	31.81	37.81	43.81
X	5.625	6.625	7.625	8.625	9.625	11.625	13.625	15.625
Y	4.375	5.375	6.375	7.375	8.375	10.375	12.375	14.375
Z	10.125	11.125	12.125	13.125	14.125	16.125	18.125	20.125



FABCO-AIR, Inc. ■ 3716 N.E. 49th Avenue ■ Gainesville, FL 32609-1699
 ■ Telephone (352) 373-3578 ■ Fax (352) 375-8024 ■ E-Mail fabco@fabco-air.com
 ■ Web Site <http://www.fabco-air.com>

Fabco-Air Product Catalog Library



Cylinders, Valves & Accessories
Catalog CV9 details Pancake[®], Square 1[®], Multi-power[®], Hi-Power[™] and Longstroke[™] air cylinder lines. Describes valves, air-over-oil tanks, boosters & accessories.

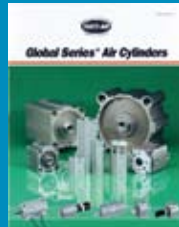

Global Series[™] Air Cylinders
Catalog # GC-15
 Widest choice of models and options. Features non-lube service to 150 psi. Bores 12mm to 100mm. Strokes 5mm to 150mm. NPT or Metric ports.



Dual Function Slides
Bulletin EDF-10
 Either of two slide styles (gantry or thruster) can be made from a single set of parts. Users can inventory less parts and assemble styles as needed.

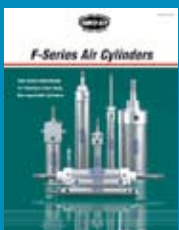

Stainless Steel Body Air Cylinders
Catalog SSB-03
 Exact interchange in bores from 5/16" to 3", strokes to 32". Popular options includes magnetic piston, non-rotating, and position feedback.



Multi-Power[®] Air Presses
Catalog FP16
 Details the powerful line of precision, force-multiplying air presses. Deliver forces to 11,000 pounds.



Swing Clamps
Bulletin #SC-DB04
 Clamp arm rotates 90° as it extends away from the workpiece. Features standard magnetic piston.

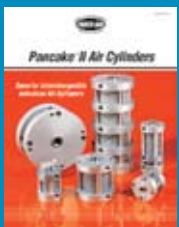

Pancake[®] II Cylinders
Catalog Pan2-2
 The direct industrial interchange. High strength composite cylinder barrel. 4 popular styles: Standard, Nonrotating, Multi-Power[®] and 3-position.



New Linear Thrusters
Bulletin GB-JA02
 Features longer strokes to 10" – and 4mm round profile sensors with surge suppression and polarity protection.



Stopper Cylinders
Bulletin #ST-DIX04
 Standard magnetic piston and a wide selection of styles. Roller direction is adjustable. Magnetic sensors can be mounted on body.



Air Preparation - FRLs
Catalog #FRL-06
 Broad line with port sizes from 1/8 NPT to 1 NPT. Includes 3-way slide valves, modular assembly and 3-way lock out/tag out valves for safe equipment maintenance.



NFPA Interchangeable Air Cylinders
Catalog NF-6
 All the desirable NFPA mounts. Bores from 1-1/2" to 6"; strokes to 99". Aluminum or high strength composite cylinder body. Magnetic position sensing.



Specialty Valves and Control Valves
Bulletin #14CAN
 Composite body solenoid valves in 2 or 3-way, N/O or N/C, and manifoldable configurations. Process Solenoid valves. 5 Ported, 3 position, 1/4 NPT 4-way air valves.



Linear Slides
Catalog # LS-03
 Line includes 6 families of slides, pick & place units, and thin parts placers. 5/16" to 4" bores. Guide shafts 1/4" to 1-1/2".

Distributed by:

